

REV.	ECN NO	CONTENT	DATE	ENGINEER
A0		Initial release	/	LYL

规格型号: Specifications:

电气特性: Electrical:

1. 额定电流: Current Rating
1.5A/contact terminal
2. 额定电压: Voltage Rating
30V DC
3. 接触阻抗: Contact Resistance
30 milliohms MAX
4. 耐电压: Dielectric Withstanding Voltage:
500 V AC AT Sea Level
5. 阻抗: Insulation Resistance:
1000MEGA ohms MIN

物理性能: Mechanical:

1. 插拔力: Connector Mate and Unmate Force
Mate force: 3.57kgf (MAX)
Unmate force: 1.02kgf (MIN)
2. 端子保持力: Terminal Retention
1.0kgf (MIN)

原材料: Material:

1. 塑膠: Housing:
Hing Temperature Ternmaplastics,
LCP Black
2. 端子: Contact: Copper Alloy C2680
3. 外壳: Shell: Copper Alloy SPCC

1. 端子: Contact: Plated Gold in Mating Area:
Tin On Solder Tails

端子四周鍍30μ(MIN) 錫, 鍍金区域鍍100-200μ鍍金1U"

2. 外壳: Shell:
外壳四周鍍80μ(MIN) 镍
Nickel Plating

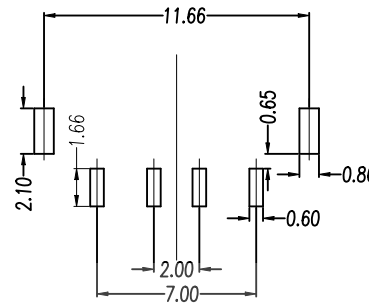
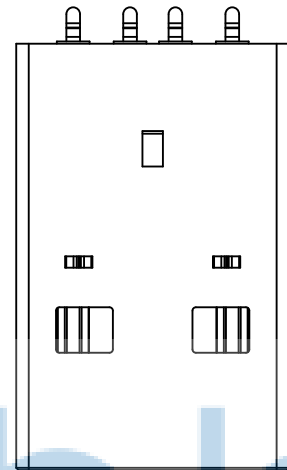

RECOMMENDED P.C.B LAYOUT

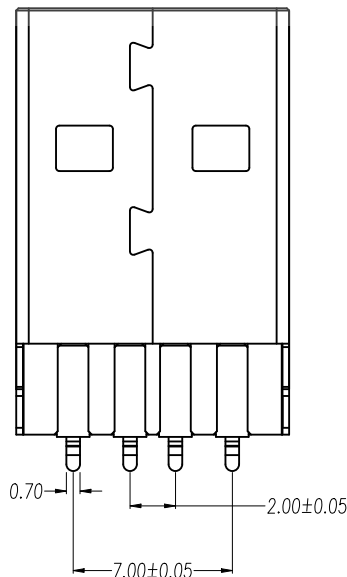
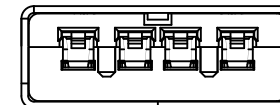
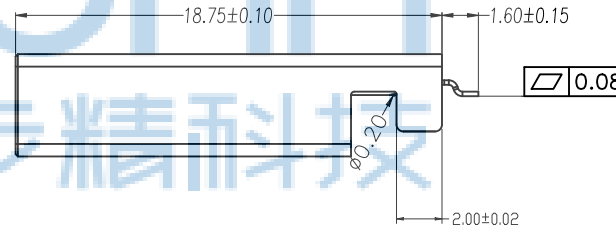
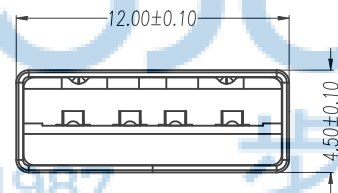
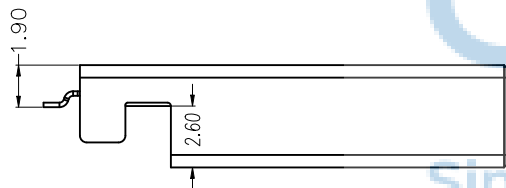

THIS DOCUMENT IS THE SOLE PROPERTY OF BBJconn Technology Co., Ltd. Corporation AND SHOULD NOT BE USED IN WHOLE OR IN PART WITHOUT PRIOR WRITTEN PERMISSION.
PDWG,NO: 0383-1

深圳市步步精科技有限公司		NAME: USB 2.0 公头 180度 卧式直脚 L=18.75 沉板2.6 无柱 端子SMT 平口 LCP黑胶 铁壳 编带	
.X: ±0.38	.X': ±3"	PJ. NO.: 127-174-090002-W7G	SIZE: A4 DRW NO.:
.XX: ±0.25	.X': ±2"		
.XXX: ±0.13	.XX': ±1"		
APPD.	JM_Zheng	FINISH: SEE NOTES MAT'L.: SEE NOTES	
CHKD.	LYX	SCALE: N/A REV.: A0 UNIT: mm PAGE: 1/2	
DR.	LYL		

REV.	ECN NO	CONTENT	DATE	ENGINEER
A0		Initial release	/	LYL

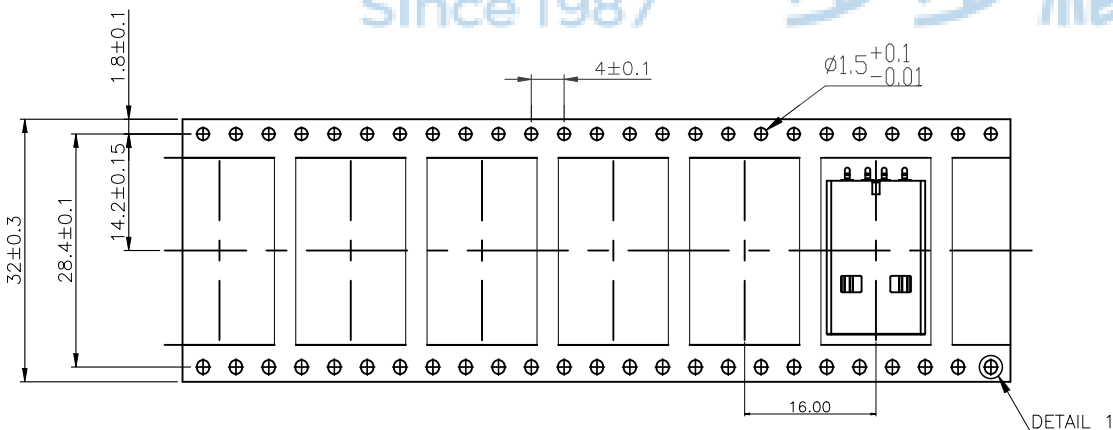
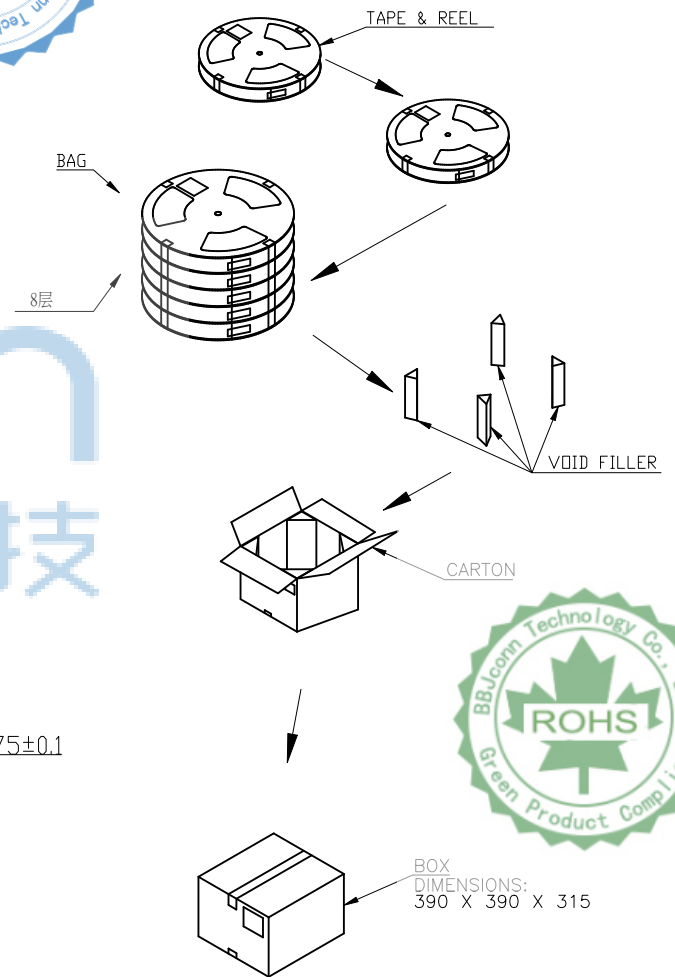
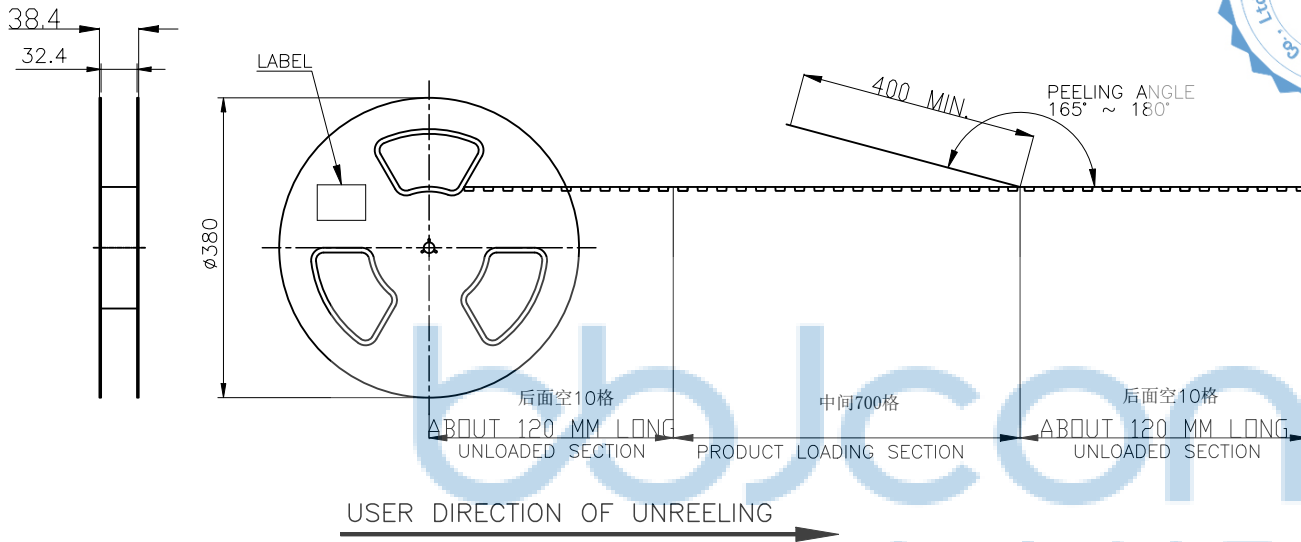

700	8	5600 PCS	-- KG	-- KG
PCS/ REEL	REELS/ CARTON	QUANTITY	GROSS WEIGHT	NET WEIGHT

THIS DOCUMENT IS THE SOLE PROPERTY OF BBJconn Technology Co.,Ltd. Corporation AND SHOULD NOT BE USED IN WHOLE OR IN PART WITHOUT PRIOR WRITTEN PERMISSION.		深圳市步步精科技有限公司 .X: ± 0.38 X': $\pm 3'$.XX: ± 0.25 .X': $\pm 2'$.XXX: ± 0.13 .XX': $\pm 1'$		NAME: USB 2.0 公头 180度 卧式直脚 L=18.75 沉板2.6 无柱 端子SMT 平口 LCP黑胶 铁壳 编带 PJ. NO.: 127-174-090002-W7G SIZE: A4 DRW NO.: FINISH: SEE NOTES MAT'L.: SEE NOTES SCALE: N/A REV.: A0 UNIT: mm PAGE: 2/2	
APPD.	JM_Zheng				
CHKD.	LYX				
PDWG.NO:	0383-1	DR.	LYL		

