

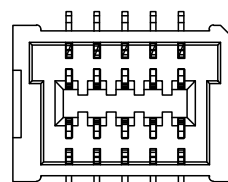

REV	ECN NO	CONTENT	DATE	ENGINEER
A0		INITIAL RELEASE	/	LYL

技术参数：

1. 额定电流：1.0A DC/AC.
2. 额定电压：50V DC/AC.
3. 耐压值：500V AC/minute.
4. 接触电阻：20m Max.
5. 绝缘电阻：100M Min.
6. 工作温度：-25 ~+85

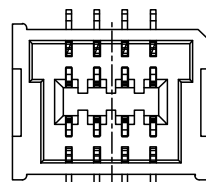
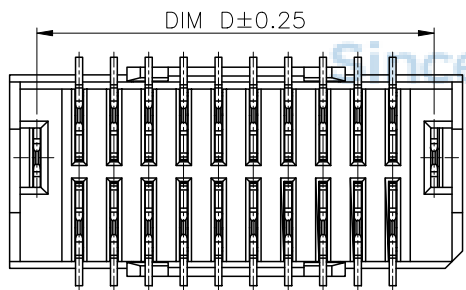
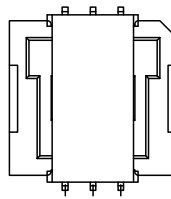
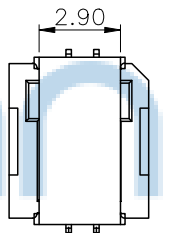
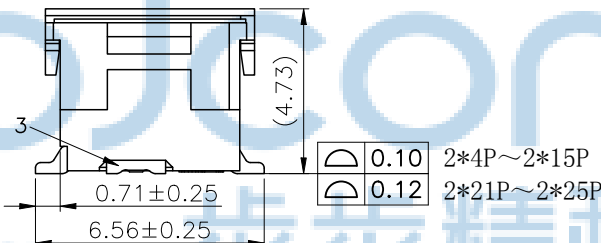
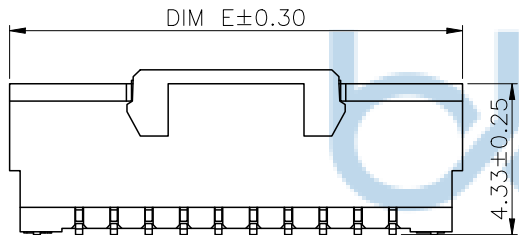
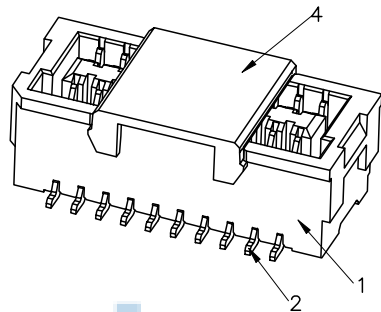
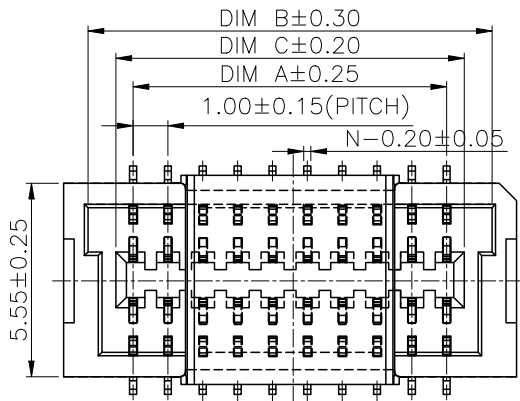

CKT	DIM A	DIM B	DIM C	DIM D	DIM E
2*2	1.00	3.60	2.00	3.42	5.00
2*3	2.00	4.60	3.00	4.42	6.00
2*4	3.00	5.60	4.00	5.42	7.00
2*5	4.00	6.60	5.00	6.42	8.00
2*6	5.00	7.60	6.00	7.42	9.00
2*7	6.00	8.60	7.00	8.42	10.00
2*8	7.00	9.60	8.00	9.42	11.00
2*9	8.00	10.60	9.00	10.42	12.00
2*10	9.00	11.60	10.00	11.42	13.00
2*11	10.00	12.60	11.00	12.42	14.00
2*12	11.00	13.60	12.00	13.42	15.00
2*13	12.00	14.60	13.00	14.42	16.00
2*14	13.00	15.60	14.00	15.42	17.00
2*15	14.00	16.60	15.00	16.42	18.00
2*16	15.00	17.60	16.00	17.42	19.00
2*17	16.00	18.60	17.00	18.42	20.00
2*18	17.00	19.60	18.00	19.42	21.00
2*19	18.00	20.60	19.00	20.42	22.00
2*20	19.00	21.60	20.00	21.42	23.00
2*21	20.00	22.60	21.00	22.42	24.00
2*22	21.00	23.60	22.00	23.42	25.00
2*23	22.00	24.60	23.00	24.42	26.00
2*24	23.00	25.60	24.00	25.42	27.00
2*25	24.00	26.60	25.00	26.42	28.00

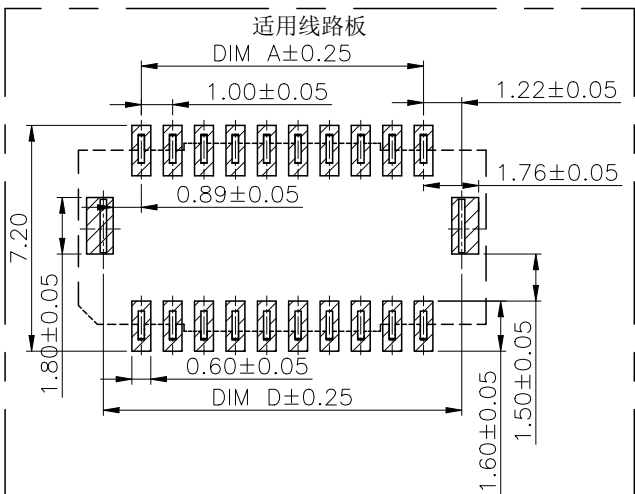

序号	产品名称	材料规格	表面处理/颜色	数量
1	胶芯	LCP	本色	1
2	端子	铜合金	镀金/镀镍	/
3	焊片	铜合金	镀锡/镀镍	2
4	吸取盖	LCP	黑色	1

THIS DOCUMENT IS THE SOLE PROPERTY OF BBJconn Technology Co.,Ltd. Corporation AND SHOULD NOT BE USED IN WHOLE PRIOR WRITTEN PERMISSION.

PDWG NO:0456-1

DR LYL

深圳市步步精科技有限公司

NAME: 针座 SHLD1.0-2x19P B型 双排 立贴 带扣 4代 无柱 米黄色 加盖 带带

APPD JM_Zheng

CHKD LYX

PJ NO: 123-244-380001-X3G

SIZE:A4

DRW NO:

FINISH:SEE NOTES

MAT'L:SEE NOTES

SCALE:N/A

REV:A0

UNIT:mm

PAGE: 1/3

REV.	ECN NO	CONTENT	DATE	ENGINEER
A0		Initial release		LYX

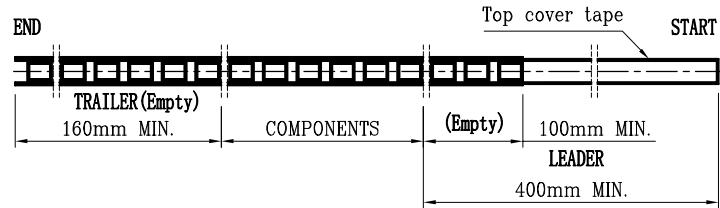

- NOTE (注):
1. 10 SPROCKET HOLE PITCH CUMULATIVE TOLERANCE $\pm 0.2\text{mm}$. (10片孔距累积公差 $\pm 0.2\text{mm}$.)
 2. CARRIER CAMBER NOT TO EXCEED 1mm IN 100mm. (载带拱/弧形MAX: 1/100mm.)
 3. ALL DIMENSIONS MEET EIA-481 REQUIREMENTS. (所有的尺寸要满足协会EIA-481规范.)
 4. MATERIAL: CLEAR ANTISTATIC PS, COLD SEALING. (载带材料: 透明抗静电 PS.)
 5. THICKNESS: $0.35 \pm 0.05\text{mm}$. (载带厚度: $0.35 \pm 0.05\text{mm}$.)
 6. PACKING LENGTH PER REEL: 12.48 METERS. (每卷包装长度: 12.48米.)
 7. COMPONENT LOAD PER REEL: 1000 PCS. (每卷包装数量: 1000只.)
 8. 纸箱装箱以不超过装箱线为准, 空余位置用塑料泡沫及保尼龙填充.
 9. 纸箱分小、中、标准型3种规格型号: 装箱为整箱(左下包装量)采用标准型纸箱包装, 未达到整箱数量以产品量适当采用小型或中型纸箱包装.

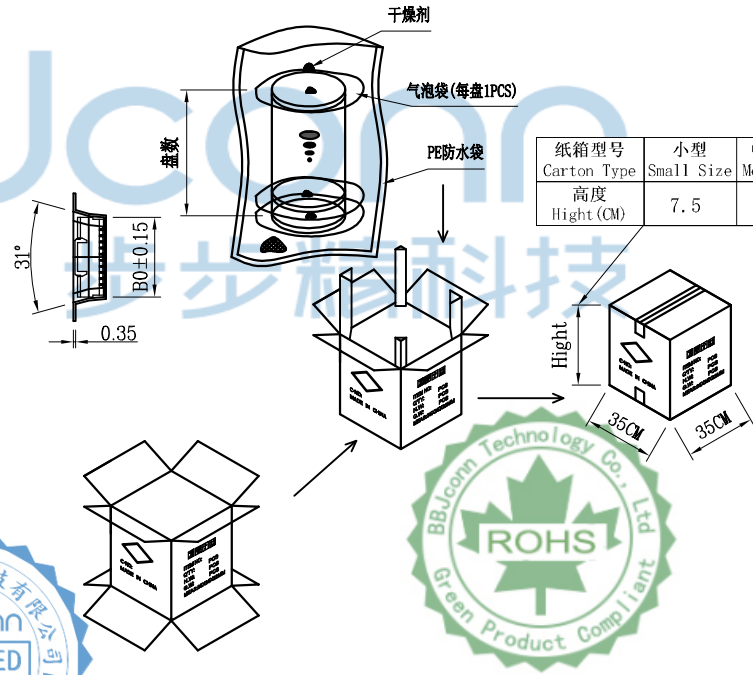
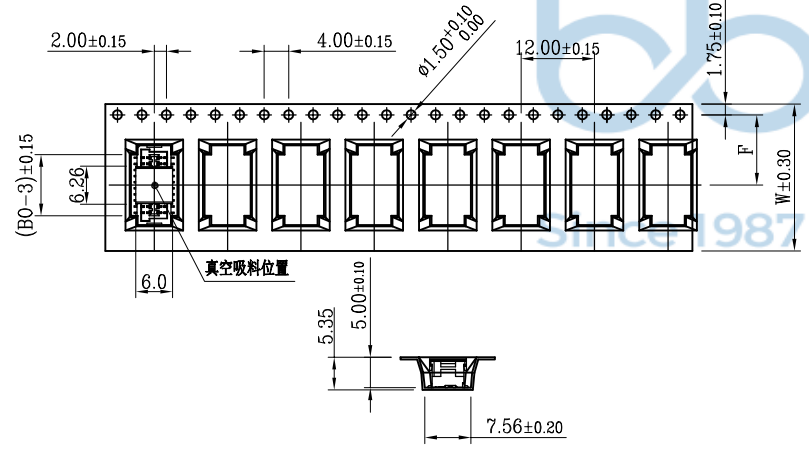
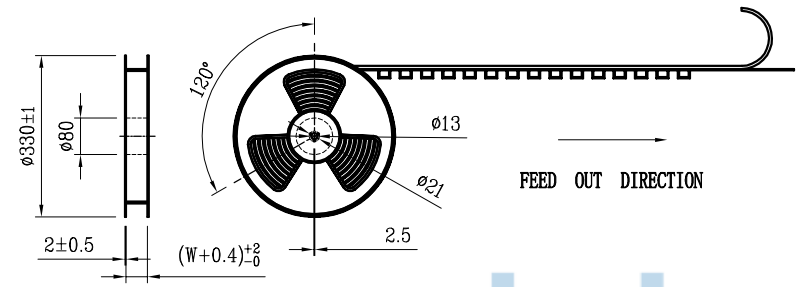

纸箱型号 Carton Type	小型 Small Size	中型 Medium	标准型 Standard
高度 Height (CM)	7.5	15	32

CKT (1.0mm pitch)	B0	W	F
2*4	7.00	16	7.50
2*5	8.00		
2*6	9.00		
2*7	10.00	24	11.50
2*8	11.00		
2*9	12.00		
2*10	13.00		
2*11	14.00		
2*12	15.00		
2*13	16.00		

CKT (1.0mm pitch)	W	PCS/RELL	RELL/CARTON	SUM (PCS)
2*4	16	1000	14	14000
2*5		1000	14	14000
2*6		1000	10	10000
2*7	24	1000	10	10000
2*8		1000	10	10000
2*9		1000	10	10000
2*10		1000	10	10000
2*11		1000	10	10000
2*12		1000	10	10000
2*13		1000	10	10000



THIS DOCUMENT IS THE SOLE PROPERTY OF BBJconn Technology Co.,Ltd. Corporation AND SHOULD NOT BE USED IN WHOLE PRIOR WRITTEN PERMISSION.

PDWG NO: 0456-1

APPD: JM_Zheng

CHKD: Tang

DR: LYX

深圳市步步精科技有限公司

NAME: 针座 SHLD1.0-2x19P B型 双排 立贴 带扣 4代 无柱 米黄色 加盖盖带

PJ NO: 123-244-380001-X3G

SIZE: A4

FINISH: SEE NOTES

SCALE: N/A

REV: A0

MAT'L: SEE NOTES

UNIT: mm

PAGE: 2/3

REV.	ECN NO	CONTENT	DATE	ENGINEER
A0		Initial release		LYX

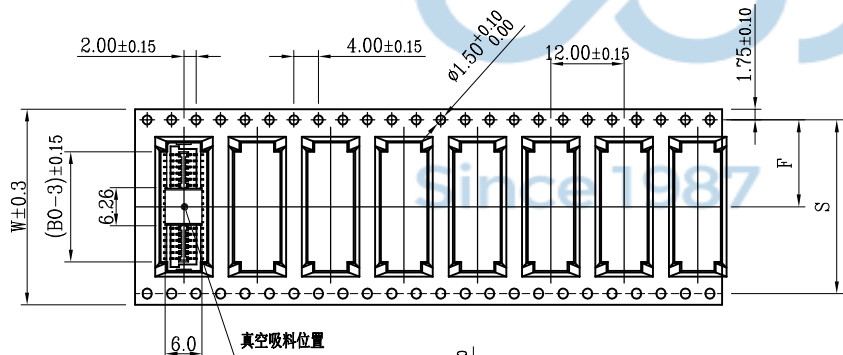
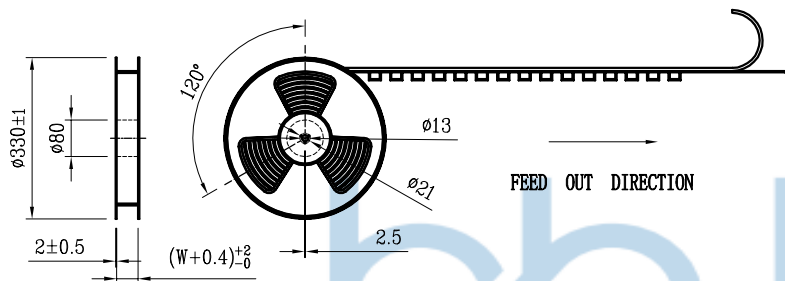
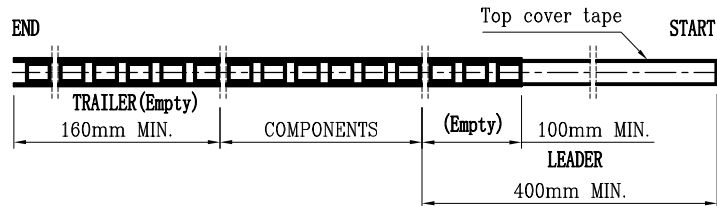

CKT (1.0mm pitch)	W	PCS/REEL	REEL/CARTON	SUM (PCS)
2*14	32	1000	8	8000
2*15		1000	8	8000
2*16		1000	8	8000
2*17		1000	8	8000
2*18		1000	8	8000
2*19	44	1000	6	6000
2*20		1000	6	6000
2*21		1000	6	6000
2*22		1000	6	6000
2*23		1000	6	6000
2*24	44	1000	6	6000
2*25		1000	6	6000
2*26		1000	6	6000
2*27		1000	6	6000
2*28		1000	6	6000
2*29		1000	6	6000
2*30		1000	6	6000

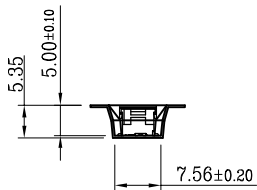

NOTE (注):

1. 10 SPROCKET HOLE PITCH CUMULATIVE TOLERANCE $\pm 0.2\text{mm}$. (10片孔距累积公差 $\pm 0.2\text{mm}$.)
2. CARRIER CAMBER NOT TO EXCEED 1mm IN 100mm. (载带拱/弧形MAX:1/100mm.)
3. ALL DIMENSIONS MEET EIA-481 REQUIREMENTS. (所有的尺寸要满足协会EIA-481规范.)
4. MATERIAL: CLEAR ANTISTATIC PS, COLD SEALING. (载带材料: 透明抗静电 PS.)
5. THICKNESS: $0.35 \pm 0.05\text{mm}$. (载带厚度: $0.35 \pm 0.05\text{mm}$.)
6. PACKING LENGTH PER REEL: 12.48 METERS. (每卷包装长度: 12.48米.)
7. COMPONENT LOAD PER REEL: 1000 PCS. (每卷包装数量: 1000只.)
8. 纸箱装箱以不超过装箱线为准, 空余位置用塑料泡沫及保尼龙填充.
9. 纸箱分小、中、标准型3种规格型号: 装箱为整箱(左下包装量)采用标准型纸箱包装, 未达到整箱数量以产品量适当采用小型或中型纸箱包装.

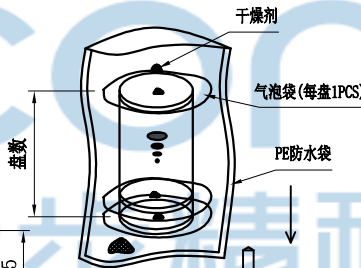

纸箱型号 Carton Type	小型 Small Size	中型 Medium	标准型 Standard
高度 Height (CM)	7.5	15	32

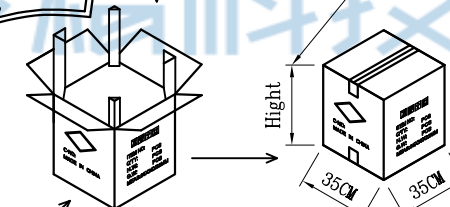

CKT (1.0mm pitch)	B0	W	F	S
2*14	17.00	32	14.2±0.15	28.40
2*15	18.00			
2*16	19.00			
2*17	20.00			
2*18	21.00			
2*19	22.00	44	20.2±0.15	40.40
2*20	23.00			
2*21	24.00			
2*22	25.00			
2*23	26.00			
2*24	27.00			
2*25	28.00			
2*26	29.00			
2*27	30.00			
2*28	31.00			
2*29	32.00			
2*30	33.00			

THIS DOCUMENT IS THE SOLE PROPERTY OF BBJconn Technology Co., Ltd. Corporation AND SHOULD NOT BE USED IN WHOLE PRIOR WRITTEN PERMISSION.

PDWG NO: 0456-1

DR LYX

深圳市步步精科技有限公司

NAME: 针座 SHLD1.0-2x19P B型 双排 立贴 带扣 4代 无柱 米黄色 加盖 盖带

PJ NO: 123-244-380001-X3G

SIZE: A4

FINISH: SEE NOTES

SCALE: N/A

MAT'L: SEE NOTES

REV: A0

UNIT: mm

PAGE: 3/3