

REV.	ECN NO	CONTENT	DATE	ENGINEER
A0				

SPECIFICATIONS

Current Rating: 3Amps
 Insulation Resistance: 1000MΩ Min
 Contact Resistance: 20mΩ Max
 Withstanding Voltage: AC 1000V
 Operation Temperature: -40° to +105°
 Contact Material: Brass
 Standard: PA6T
 Insulator Material: Polyester (UL 94V-0)
 Contact Plating: Gold Flash
 Max. Processing Temp: 240° C for 30-60 seconds
 (260° C for 5 seconds)

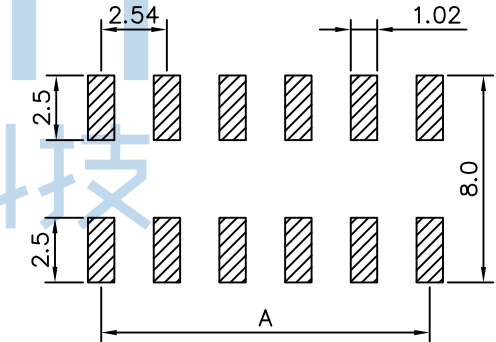
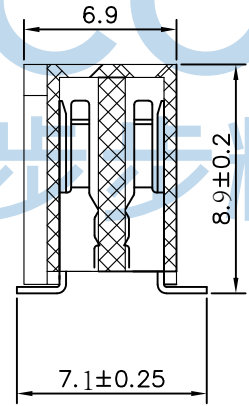
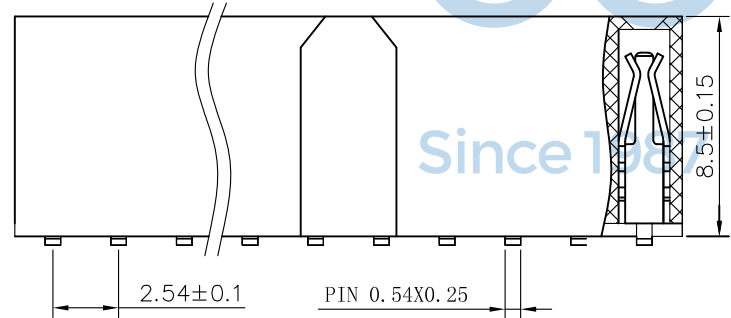
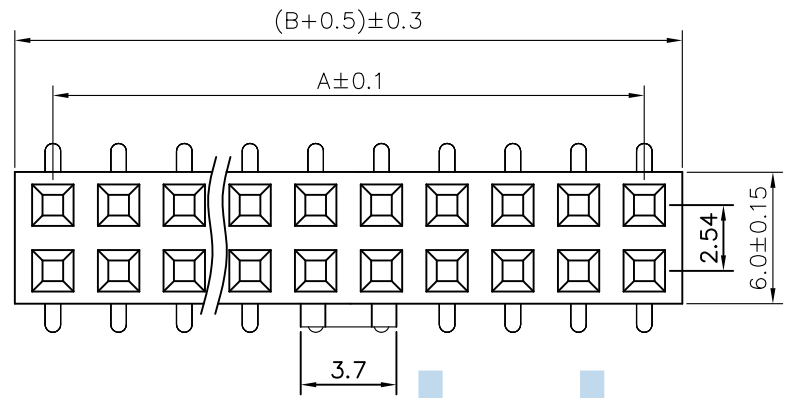

RECOMMEND P. C. B LAYOUT
 PCB TOLERANCE: ±0.05 (TOP VIEW)



No. of	DIM. A	DIM. B	No. of	DIM. A	DIM. B	No. of	DIM. A	DIM. B	No. of	DIM. A	DIM. B
1	0.00	2.54	11	25.40	27.94	21	50.80	53.34	31	76.20	78.74
2	2.54	5.08	12	27.94	30.48	22	53.34	55.88	32	78.74	81.28
3	5.08	7.62	13	30.48	33.02	23	55.88	58.42	33	81.28	83.82
4	7.62	10.16	14	33.02	35.56	24	58.42	60.96	34	83.82	86.36
5	10.16	12.70	15	35.56	38.10	25	60.96	63.50	35	86.36	88.90
6	12.70	15.24	16	38.10	40.64	26	63.50	66.04	36	88.90	91.44
7	15.24	17.78	17	40.64	43.18	27	66.04	68.58	37	91.44	93.98
8	17.78	20.32	18	43.18	45.72	28	68.58	71.12	38	93.98	96.52
9	20.32	22.86	19	45.72	48.26	29	71.12	73.66	39	96.52	99.06
10	22.86	25.40	20	48.26	50.80	30	73.66	76.20	40	99.06	101.60

THIS DOCUMENT IS THE SOLE PROPERTY OF BBJconn Technology Co., Ltd. Corporation AND SHOULD NOT BE USED IN WHOLE OR IN PART WITHOUT PRIOR WRITTEN PERMISSION.

PDWG. NO: 0266-1

DR. LHC

APPD. JM_Zheng

CHKD. LYX

NAME: 排母 2.54FH H8.5 2x14P SMT带全凸 U型 PC7.1 PB8.9 6T 贴膜编带

PJ. NO.: FH.05.22-43-3002

SIZE: A4 | DRW NO.:

FINISH: SEE NOTES | MAT'L.: SEE NOTES

SCALE: N/A | REV.: A0 | UNIT: mm | PAGE: 1/2

REV.	ECN NO	CONTENT	DATE	ENGINEER
AO		Initial Release	/	LHC

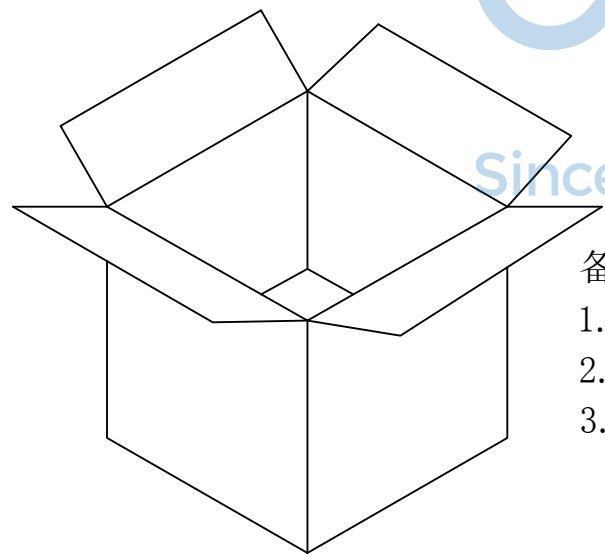
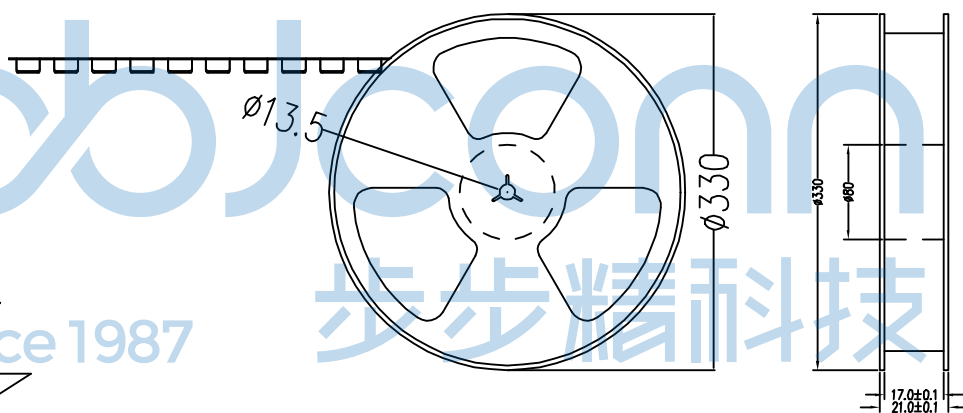
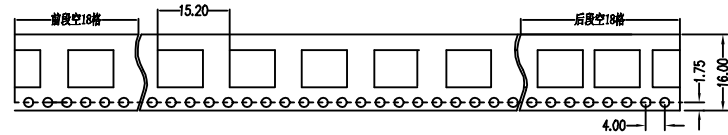
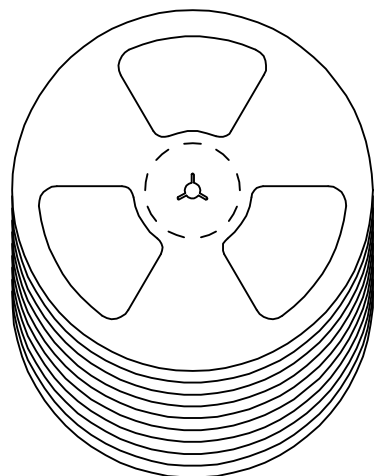

备注:

1. 包装数量: 400/PCS/卷, 10卷/箱。
2. 包装袋长度: 每卷前后各空10-20个空格, 中间包装。
3. 材质:
 载体: 聚丙烯 (PS), 阻抗 $10^{6-9} \Omega$
 上带: 聚乙烯 (PET), 阻抗 $10^{6-11} \Omega$
 卷盘: 聚苯乙烯。

纸箱规格: 345*345*23MM
 纸箱规格: 345*345*35MM

THIS DOCUMENT IS THE SOLE PROPERTY OF BBJconn Technology Co.,Ltd. Corporation AND SHOULD NOT BE USED IN WHOLE OR IN PART WITHOUT PRIOR WRITTEN PERMISSION.		深圳市步步精科技有限公司	
.X: ±0.38 .XX: ±0.25 .XXX: ±0.13		X': ±3' .X': ±2' .XX': ±1'	
APPD. JM_Zheng		NAME: 排母 2.54FH H8.5 2x14P SMT带全凸 U型 PC7.1 PB8.9 6T 贴膜编带	
CHKD. LYX		PJ. NO.: FH.05.22-43-3002 SIZE: A4 DRW NO.:	
DR. LHC		FINISH: SEE NOTES MAT'L.: SEE NOTES	
PDWG.NO: 0266-1		SCALE: N/A REV.: AO UNIT: mm PAGE: 2/2	