

REV.	ECN NO.	CONTENT	DATE	ENGINEER
A0		Initial release	/	SGF

1. Rating: DC12V 50mA.
2. Travel:  $0.3 \pm 0.1$ mm.
3. Operating Force:  $250 \pm 50$ gf
4. Contact Resistance:  $50m\Omega$  Max.
5. Life: 200,000 Cycles Min.

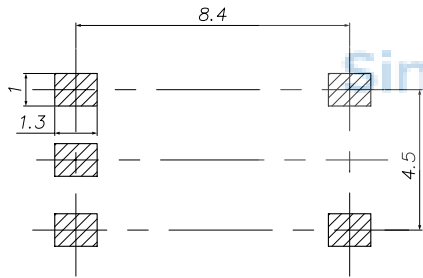

印制线路板  
Recommended P.C.B layout

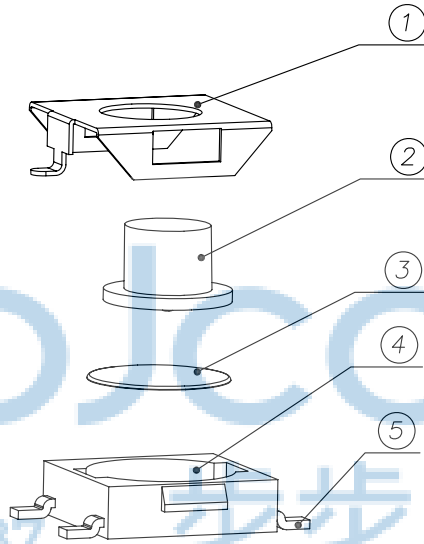
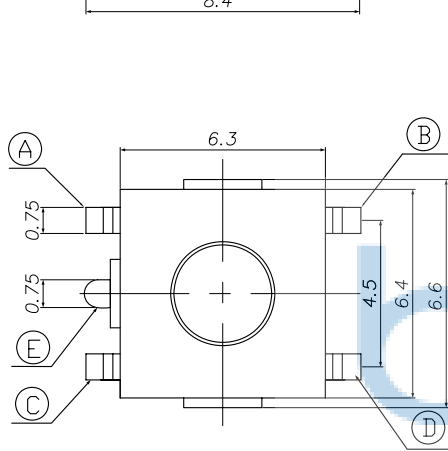
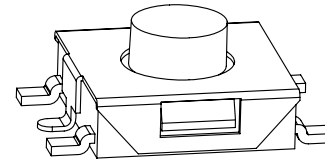
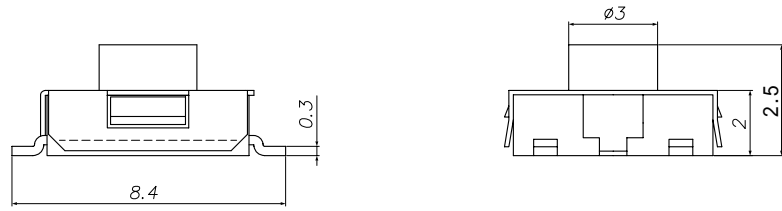
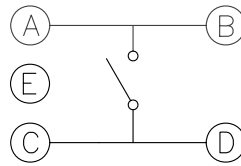

电路简图  
SCHEMATIC

5	嵌件	黄铜	—	镀银
4	基座	PPA	黑色	—
3	弹片	不锈钢	—	—
2	帽头	PPA	黑色	—
1	盖板	磷铜	—	镀铜锡
序号 NO.	名称 DESCRIPTION	材料 MATERIAL	颜色 COLOR	备注 REMARK



THIS DOCUMENT IS THE SOLE PROPERTY OF BBJconn Technology Co., Ltd. Corporation AND SHOULD NOT BE USED IN WHOLE OR IN PART WITHOUT PRIOR WRITTEN PERMISSION.		<b>深圳市步步精科技有限公司</b>	
PDWG.NO: 0160-2		DR. SGF	APPD. JM_Zheng
NAME: 轻触开关 6.2x6.2x2.5 五脚贴片 环保 耐高温 黑柄 260G 不锈钢弹片		PJ. NO.: TS.18.07-71-36-02	
FINISH: SEE NOTES		MAT'L.: SEE NOTES	
SCALE: N/A		REV.: A0	UNIT: mm
PAGE: 1/2			

REV.	ECN NO	CONTENT	DATE	ENGINEER
A0		Initial release	/	SGF

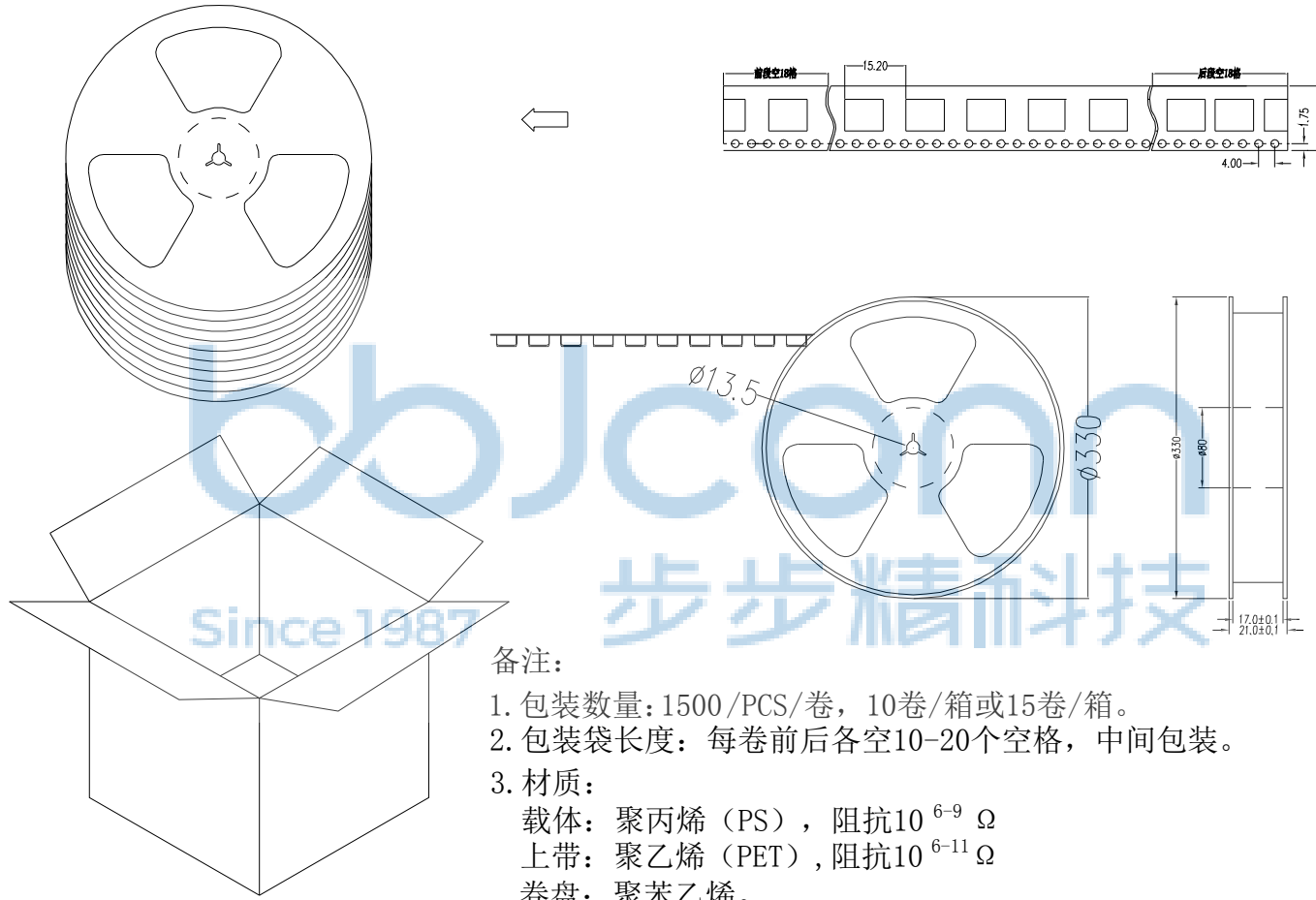

备注：  
 1. 包装数量：1500/PCS/卷，10卷/箱或15卷/箱。  
 2. 包装袋长度：每卷前后各空10-20个空格，中间包装。  
 3. 材质：  
 载体：聚丙烯（PS），阻抗 $10^{6-9} \Omega$   
 上带：聚乙烯（PET），阻抗 $10^{6-11} \Omega$   
 卷盘：聚苯乙烯。  
 纸箱规格：345\*345\*23MM  
 纸箱规格：345\*345\*35MM

THIS DOCUMENT IS THE SOLE PROPERTY OF BBJconn Technology Co.,Ltd. Corporation AND SHOULD NOT BE USED IN WHOLE OR IN PART WITHOUT PRIOR WRITTEN PERMISSION.		深圳市步步精科技有限公司	
.X: ±0.38 .XX: ±0.25 .XXX: ±0.13		X*: ±3* X*: ±2* XX*: ±1*	
APPD.	JM_Zheng	NAME: 轻触开关 6.2x6.2x2.5 五脚贴片 环保耐高温 黑柄 260G 不锈钢弹片	
CHKD.	LYX	PJ. NO.: TS.18.07-71-36-02	
DR.	SGF	SIZE: A4 DRW NO.:	
PDWG.NO: 0160-2		FINISH: SEE NOTES MAT'L.: SEE NOTES	
		SCALE: N/A REV.: A0 UNIT: mm PAGE: 2/2	