

REV.	ECN NO	CONTENT	DATE	ENGINEER
A0				

主要技术指标:
Main Specifications:

气候等级 Climate grade	额定值 Rated values	接触电阻 Contact resistance	耐压 Dielectric strength	绝缘电阻 Insulation resistance	行程 Travel	寿命 Life
-20℃~+70℃	Max50 mA12V Min10 μA1V DC	≤100mΩ	250V. AC. 1Min	≥50MΩ	0.27±0.1mm	100000次

0.27±0.1MM

Travel

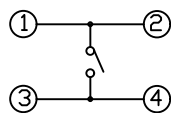
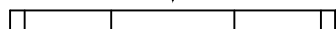

CIRCUIT DIAGRAM

序号	高度(H)	按力(gf)
1	0.73H	160±30gf
2	0.73H	260±30gf

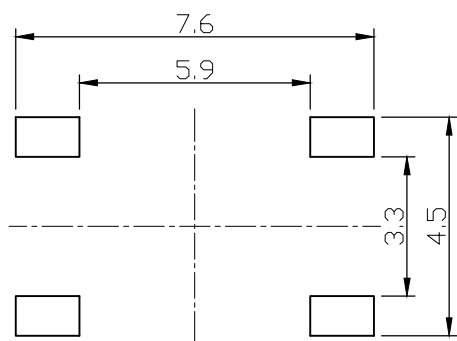
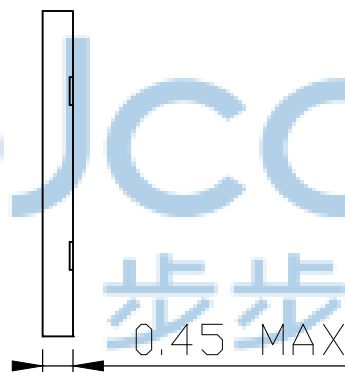
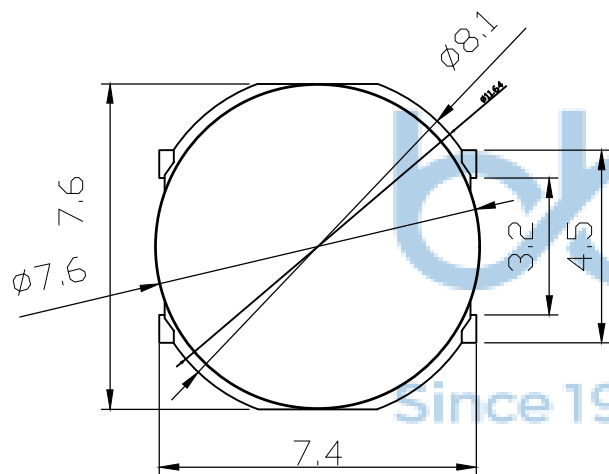

序号	名称	数量	材料	备注
4	端子	1	磷青铜	镀银
3	黄膜	1	聚酰亚胺	黄色
2	弹片	1	SUS	镀银
1	塑胶底座	1	PA6T	黑色

THIS DOCUMENT IS THE SOLE PROPERTY OF BBJconn Technology Co., Ltd. Corporation AND SHOULD NOT BE USED IN WHOLE OR IN PART WITHOUT PRIOR WRITTEN PERMISSION.

PDWG.NO: 0131-2

DR. TSP

深圳市步步精科技有限公司

NAME: 轻触开关 7.6x7.4x0.45 四脚贴片 黄膜 不锈钢弹片 260gf

PJ. NO.: TS.43.73-11-3A-01

SIZE: A4 | DRW NO.:

FINISH: SEE NOTES | MAT'L.: SEE NOTES

SCALE: N/A | REV.: A0 | UNIT: mm | PAGE: 1/2

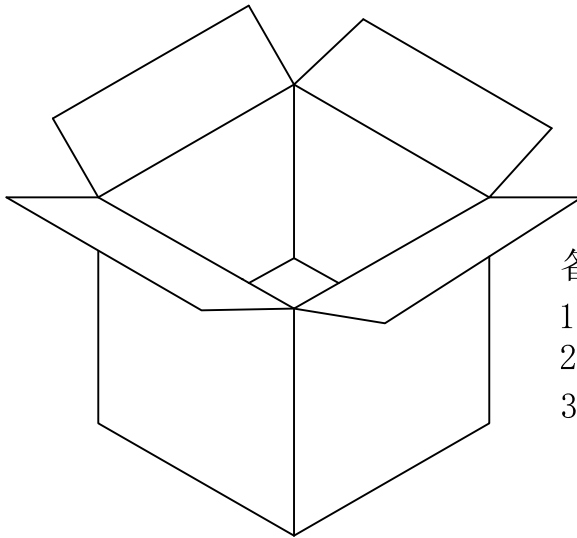
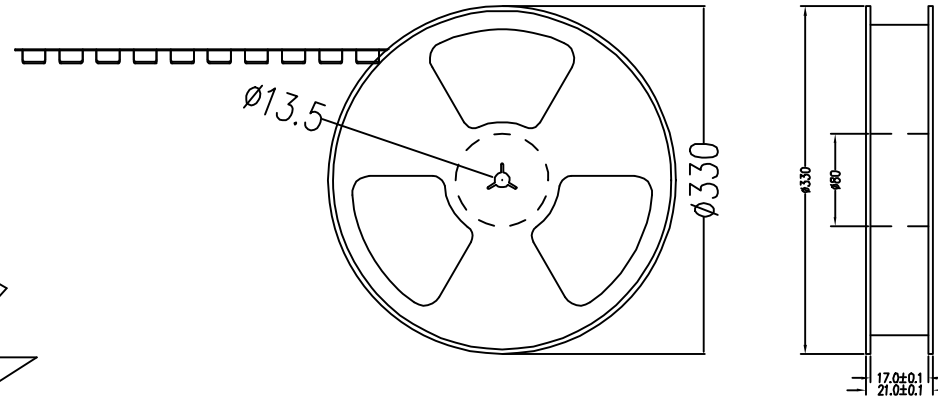
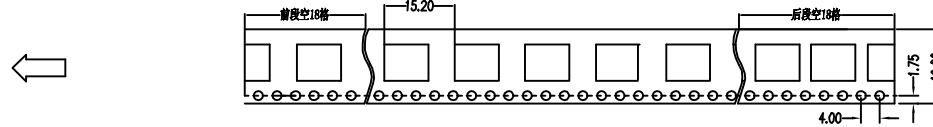
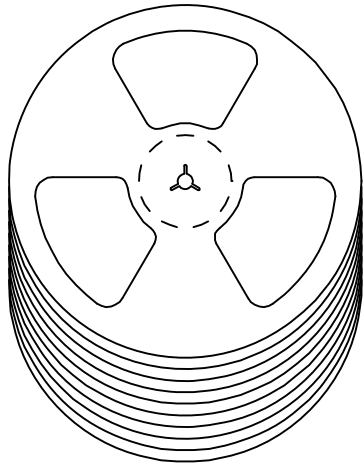

备注:

1. 包装数量: 4000/PCS
2. 包装袋长度: 每卷前后各空10-20个空格, 中间包装。
3. 材质:
载体: 聚丙烯 (PS), 阻抗 $10^{6-9} \Omega$
上带: 聚乙烯 (PET), 阻抗 $10^{6-11} \Omega$
卷盘: 聚苯乙烯。

纸箱规格: 345*345*23MM
纸箱规格: 345*345*35MM

THIS DOCUMENT IS THE SOLE PROPERTY OF BBJconn Technology Co.,Ltd Corporation AND SHOULD NOT BE USED IN WHOLE OR IN PART WITHOUT PRIOR WRITTEN PERMISSION.		深圳市步步精科技有限公司	
.X: ±0.38 .XX: ±0.25 .XXX: ±0.13		X: ±3' .X: ±2' .XX: ±1'	
APPD.	JM_Zheng	NAME: 长沙市步步精科技有限公司	
CHKD.	LYX	Çá¸¸¹Ø 7.6x7.4x0.45 ÈÃ½ÁüÈ¬ »ÆÃ»»Ðà, ÖµÆ¬ 260gf	
DR.	TSP	P.J. NO.: TS.43.73-11-3A-01	
PDWG.NO: 0131-2		SIZE: A4 DRW NO.:	
		FINISH: SEE NOTES MAT'L.: SEE NOTES	
		SCALE: N/A REV.: A0 UNIT: mm PAGE: 2/2	