

主要技术指标:
Main Specifications:

气候等级 Climate grade	额定值 Rated values	接触电阻 Contact resistance	耐压 Dielectric strength	绝缘电阻 Insulation resistance	行程 Travel	寿命 Life
-30℃~+85℃	Max50 mA12V DC Min10 μA1V DC	≤500mΩ	100V. AC. 1Min	≥100mΩ	0.13±0.05mm	100000次

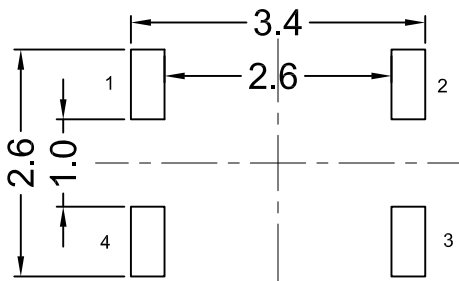
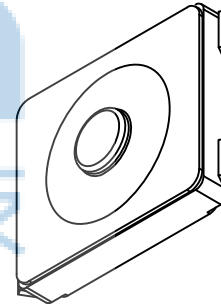
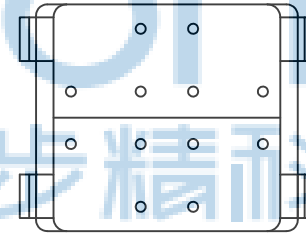
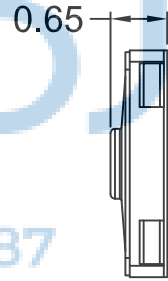
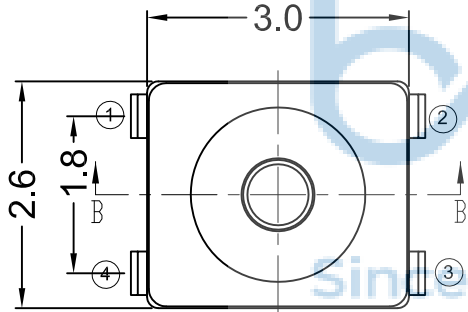
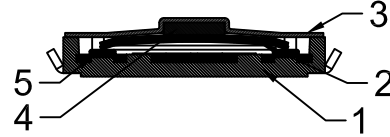
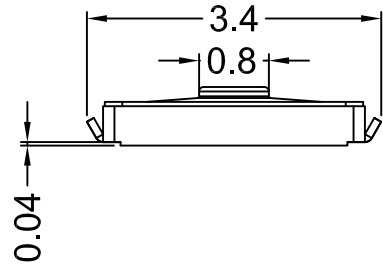

PCB.layout

Circuit Diagram

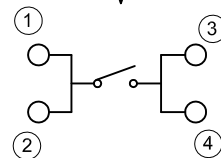

序号	名称	数量	材料	备注
5	胶点	1	聚酰亚胺	黑色
4	端子	1	C5191	镀银
3	黄膜	1	聚酰亚胺	黄(透明)
2	弹片	2	SUS301-Ag0.5	单面镀银
1	塑胶底座	1	PA	黑色

THIS DOCUMENT IS THE SOLE PROPERTY OF BBJconn Technology Co.,Ltd. Corporation AND SHOULD NOT BE USED IN WHOLE OR IN PART WITHOUT PRIOR WRITTEN PERMISSION.

深圳市步步精科技有限公司

NAME: 轻触开关 3x2.6x0.65 全包贴片 带点黄膜 不锈钢双弹片 160g

APPD. JM_Zheng

CHKD. LYX

DR. SGF

PJ. NO.: TS.40.72-12-3S-01

SIZE: A4 | DRW NO.:

FINISH: SEE NOTES | MAT'L.: SEE NOTES

SCALE: N/A | REV.: A0 | UNIT: mm | PAGE: 1/2

REV.	ECN NO	CONTENT	DATE	ENGINEER
A0		Initial release	/	SGF

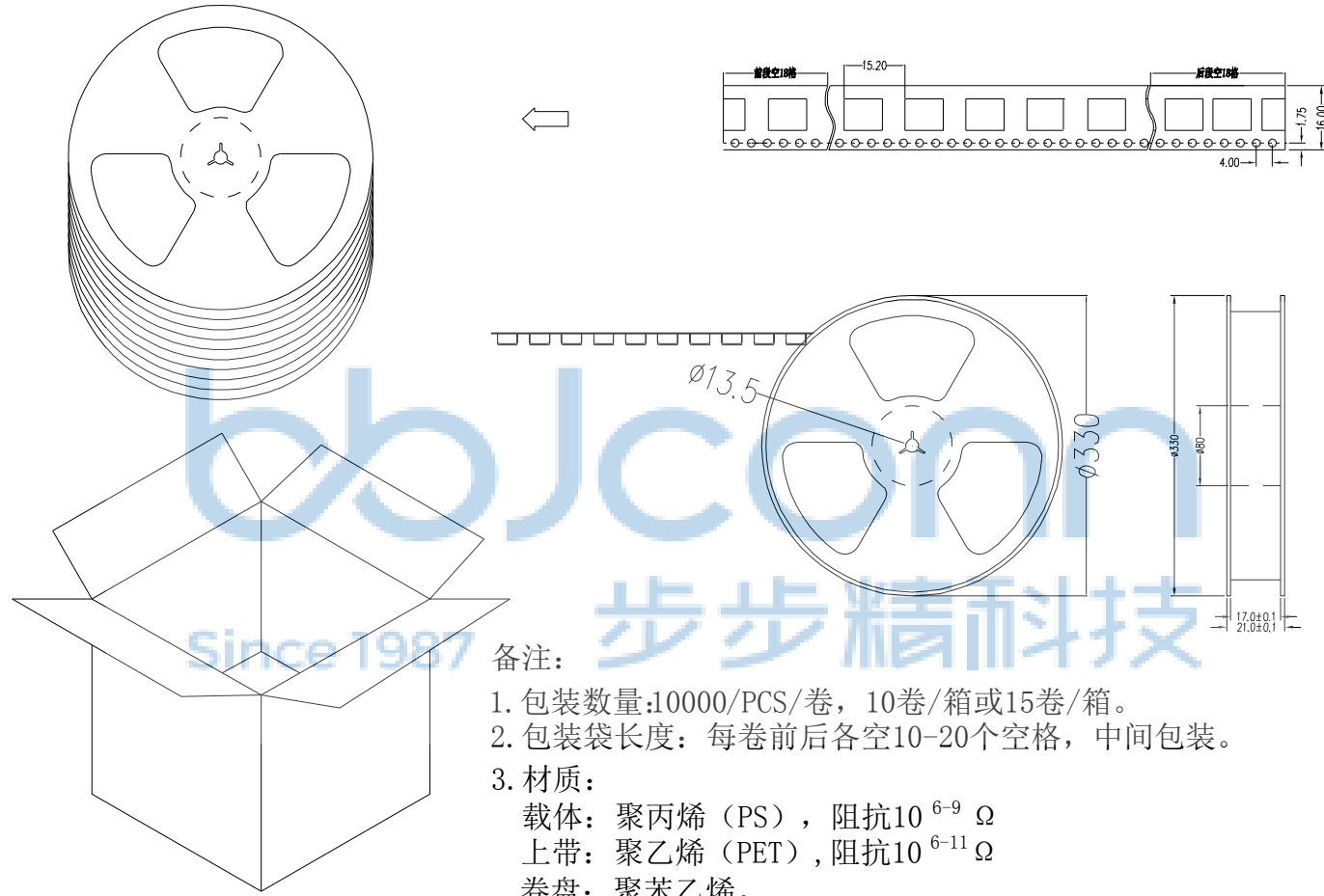

备注：
 1. 包装数量:10000/PCS/卷，10卷/箱或15卷/箱。
 2. 包装袋长度：每卷前后各空10-20个空格，中间包装。
 3. 材质：
 载体：聚丙烯（PS），阻抗 $10^{6-9} \Omega$
 上带：聚乙烯（PET），阻抗 $10^{6-11} \Omega$
 卷盘：聚苯乙烯。
 纸箱规格：345*345*23MM
 纸箱规格：345*345*35MM

THIS DOCUMENT IS THE SOLE PROPERTY OF BBJconn Technology Co.,Ltd. Corporation AND SHOULD NOT BE USED IN WHOLE OR IN PART WITHOUT PRIOR WRITTEN PERMISSION.		深圳市步步精科技有限公司 .X: ±0.38 .X': ±3" .XX: ±0.25 .X': ±2" .XXX: ±0.13 .XX': ±1"		NAME: 轻触开关 3x2.6x0.65 全包贴片 带点黄膜 不锈钢双弹片 160g	
APPD.	JM_Zheng	PJ. NO.: TS.40.72-12-3S-01 SIZE: A4 DRW NO.:		FINISH: SEE NOTES MAT'L.: SEE NOTES	
CHKD.	LYX	SCALE: N/A		REV.: A0	UNIT: mm
PDWG.NO:	0131-1	DR.	SGF	PAGE: 2/2	