

REV.	ECN NO.	CONTENT	DATE	ENGINEER
A0		Initial release	/	SGF

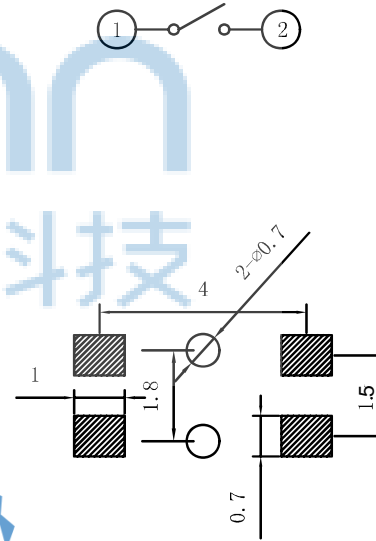

Since 1987

步步精科技

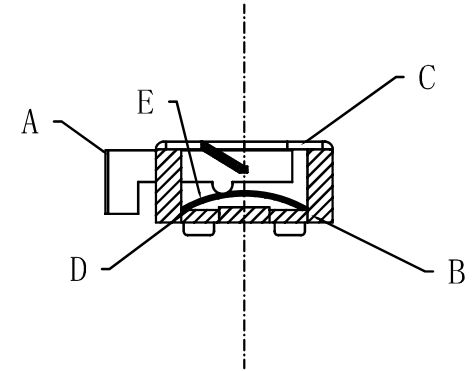
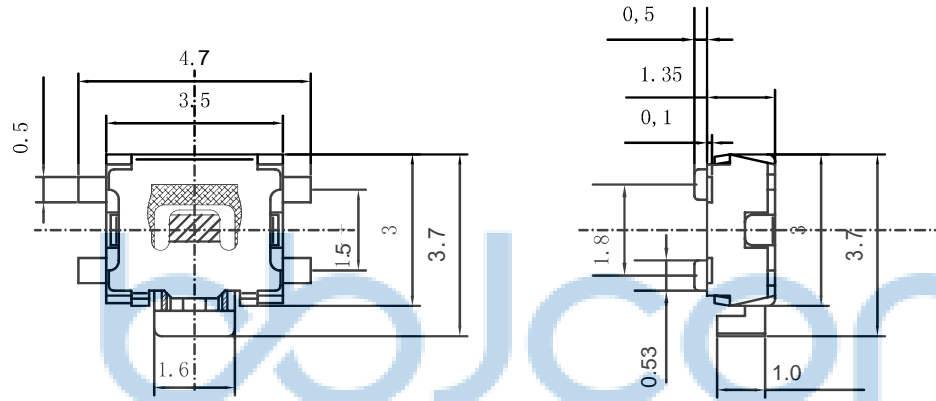

项 目	规 格
额定电负荷:	DC12V 50mA
绝缘电阻:	≥100MΩ
耐压强度:	AC250V 50Hz/1min
电气寿命:	30,000 cycles Min
环境温度:	-25°c ~ +70°c
相对湿度:	(40°c) ≤95%
接触电阻:	≤30mΩ
行程:	0.2±0.05mm
动作力:	260 ± 30gf

序号	名 称	数量	材 料	镀涂 颜色
E	薄 膜	1~2	聚酰亚胺 (杜邦)	黄 色
D	接 触 簧 片	1	不 锈 钢	银白色镶银
C	盖 子	1	不 锈 钢	银 白 色
B	底 座	1	尼 龙	黑色与镀银
A	主 轴	1	尼 龙	黑 色

THIS DOCUMENT IS THE SOLE PROPERTY OF BBJconn Technology Co., Ltd. Corporation AND SHOULD NOT BE USED IN WHOLE OR IN PART WITHOUT PRIOR WRITTEN PERMISSION.

PDWG.NO: 0278-1

DR. SGF

APPD. JML\_Zheng

CHKD. LYX

APPROVED

深圳市步步精科技有限公司

NAME: 轻触开关 3x3.5x1.35 侧插 有柱 四脚小龟 260G

PJ. NO.: TS.27.68-11-38-01

SIZE: A4 | DRW NO.:

FINISH: SEE NOTES | MAT'L.: SEE NOTES

SCALE: N/A | REV.: A0 | UNIT: mm | PAGE: 1/2

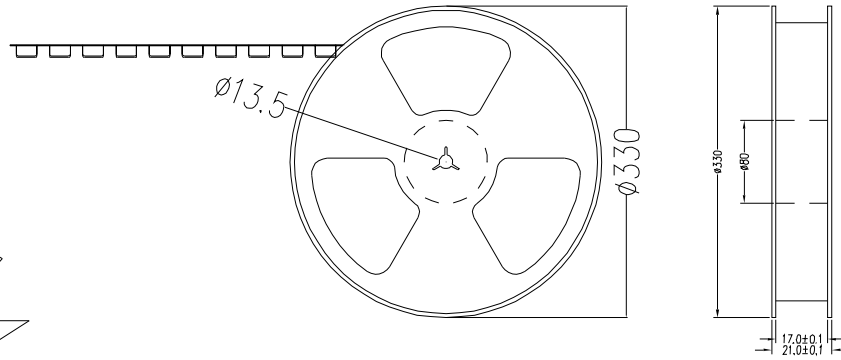
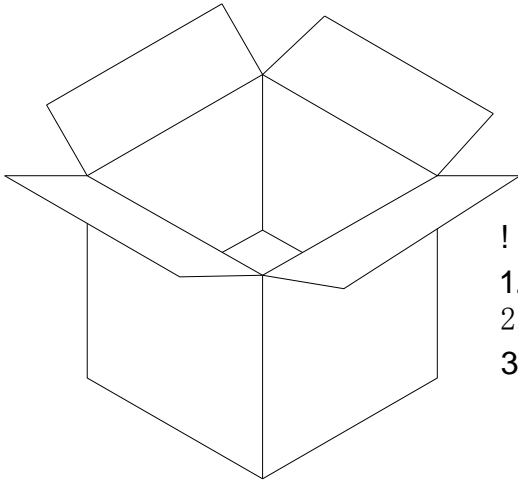
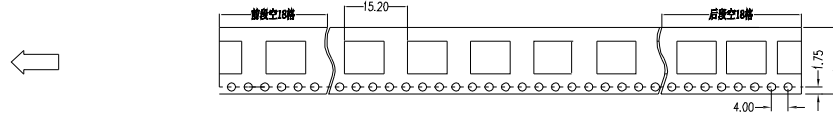
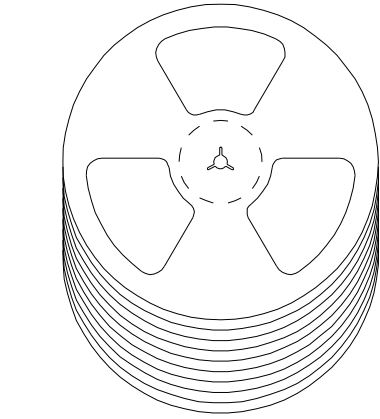

! " #

1. 包装数量: 3000/PCS/卷, 10G /) \* 15G /) +
2. 包装袋长度: 每卷前后各空10- 20个空格, 中间包装。

3. 8 9 #

: ; # < = > ? PS@ ( A B 10<sup>6-9</sup> C  
D E # < F > ? PET), 阻抗10<sup>6-11</sup>Ω

卷盘: 聚苯乙烯。

纸箱规格: 345\* 345\* 23MM

I ) J 5 # 345\* 345\* 35MM

THIS DOCUMENT IS THE SOLE PROPERTY OF BBJconn Technology Co.,Ltd. Corporation AND SHOULD NOT BE USED IN WHOLE OR IN PART WITHOUT PRIOR WRITTEN PERMISSION.				\$! c 2!•!•2!0 ° 9L€ œ (	
PDWG.NO: 0278-1		DR.	SGF	NAME: Çá ¥¿ a1Ø 3x3.5x1.35 ²à²à ÓÐÖù ÈÁ½ÄDj1é 260G	
APPD. JM_Zheng				PJ. NO.: TS.27.68-11-38-01	
CHKD. LYX		FINISH: SEE NOTES		MAT'L.: SEE NOTES	
SCALE: N/A		REV.: A0	UNIT: mm	PAGE: 2/2	