

REV.	ECN NO	CONTENT	DATE	ENGINEER
AO				

技术要求:

- 1 零部件表面光洁无划伤, 水花, 变形, 影响外观及性能等缺陷.
- 2 额定电流: 50mA 12V DC, 绝缘电阻100MΩ min, 100V DC, 介电强度250V AC for 1min, 接触电阻100mΩ max .
- 3 开关手感明显, 档位清晰可靠, 无卡滞现象, 消除外力后, 应能快速回位.

单位 (mm)			
H	2.0	2.5	3.0

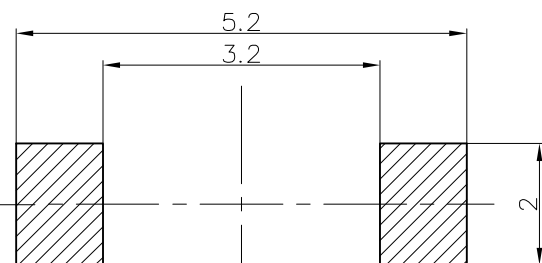
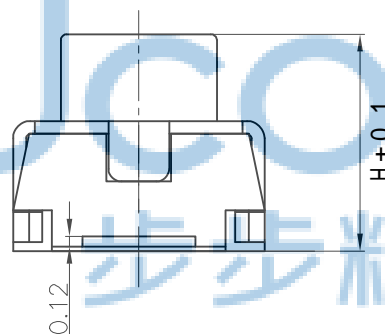
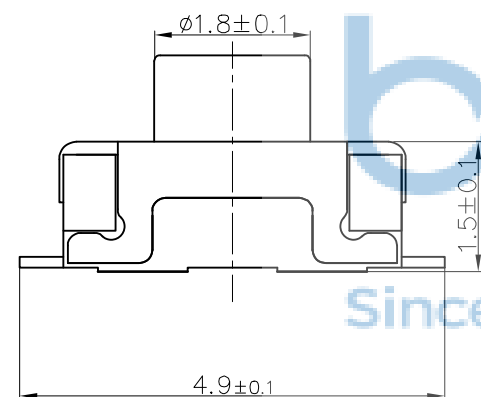
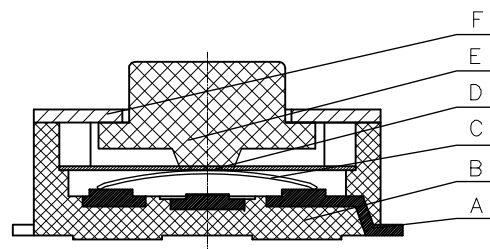
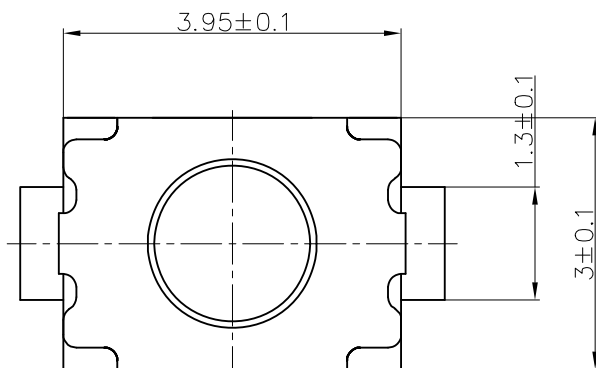

安装参考图

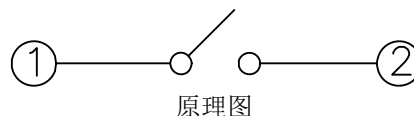

序号	名称	材料	数量	备注
F	盖板	不锈钢0.15	1	酸洗
E	按钮	LCP黑	1	
D	防水膜	0.05	1	外购
C	簧片	不锈钢覆银	2	外购
B	底座	LCP黑	1	
A	卡件	磷铜0.12Y	1	镀银

THIS DOCUMENT IS THE SOLE PROPERTY OF BBJconn Technology Co.,Ltd. Corporation AND SHOULD NOT BE USED IN WHOLE OR IN PART WITHOUT PRIOR WRITTEN PERMISSION.

PDWG:NO: 0278-1

APPD. JM_Zheng

CHKD. TSP

DR. LYX

深圳市步步精科技有限公司

NAME: 轻触开关 3x4x2.0 两脚小贴片片 无柱 不锈钢双弹片 160GF 黑柄

PJ. NO.: TS.20.06-12-38-01

SIZE: A4 DRW NO.:

FINISH: SEE NOTES MAT'L.: SEE NOTES

SCALE: N/A REV.: AO UNIT: mm PAGE: 1/1

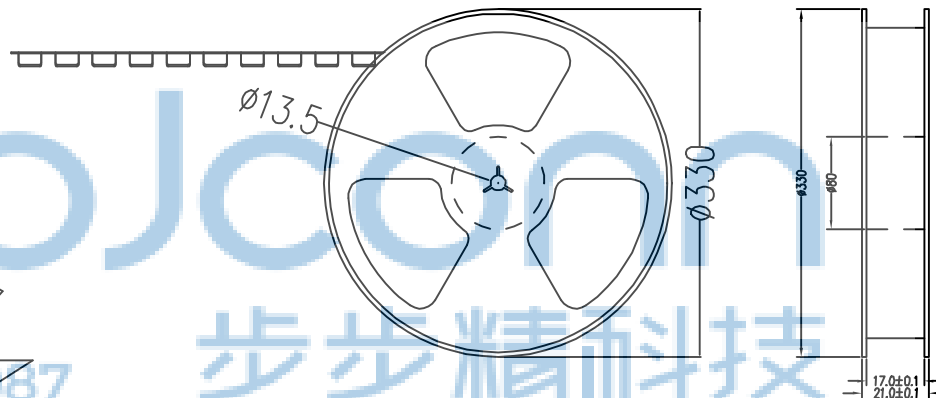
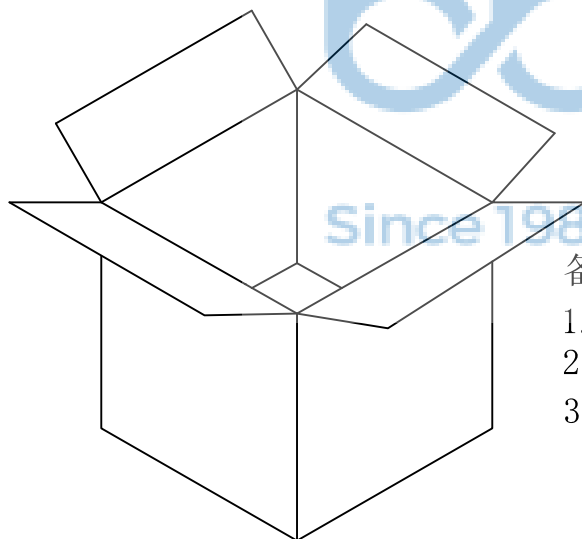
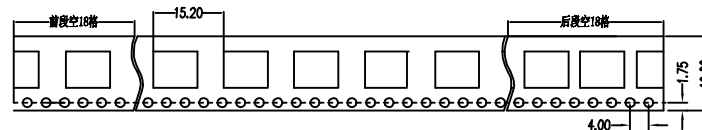
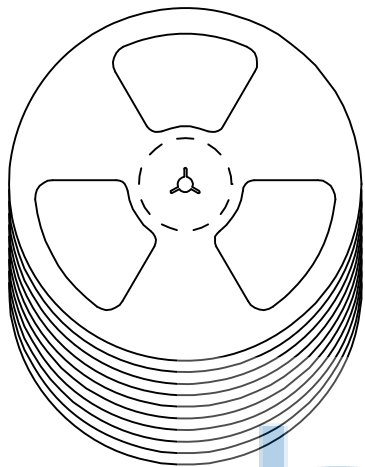

备注:

1. 包装数量: 3000/PCS
2. 包装袋长度: 每卷前后各空10-20个空格, 中间包装。
3. 材质:
载体: 聚丙烯 (PS), 阻抗 $10^{6-9} \Omega$
上带: 聚乙烯 (PET), 阻抗 $10^{6-11} \Omega$
卷盘: 聚苯乙烯。

纸箱规格: 345*345*23MM

纸箱规格: 345*345*35MM

THIS DOCUMENT IS THE SOLE PROPERTY OF BBJconn Technology Co.,Ltd Corporation AND SHOULD NOT BE USED IN WHOLE OR IN PART WITHOUT PRIOR WRITTEN PERMISSION.		深圳市步步精科技有限公司 .X: ±0.38 .X': ±3' .XX: ±0.25 .X': ±2' .XXX: ±0.13 .XX': ±1'		NAME: 轻触开关 3x4x2.0 两脚小龟贴片 无柱 不锈钢双弹片 160GF 黑柄 P.J. NO.: TS.20.06-12-38-01 SIZE: A4 DRW NO.: FINISH: SEE NOTES MAT'L.: SEE NOTES SCALE: N/A REV.: A0 UNIT: mm PAGE: 1/1	
APPD.	JM_Zheng	CHKD.	TSP	DR.	LYX
PDWG.NO: 0278-1					