

REV.	ECN NO.	CONTENT	DATE	ENGINEER
AO				

项目	规格
额定负荷	DC 12V 50mA
绝缘电阻	100MΩ min. 100v DC
耐压强度	AC250V 50Hz 1min
电器寿命	30000次-100000次
环境温度	-25~70℃
相对湿度	(40℃) ≤ 95%
接触电阻	50mΩ max
行程	0.20 ± 0.05mm
动作力	100/160/260gf ± 30gf

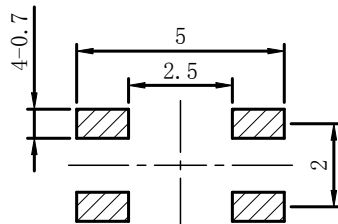

安装参考图

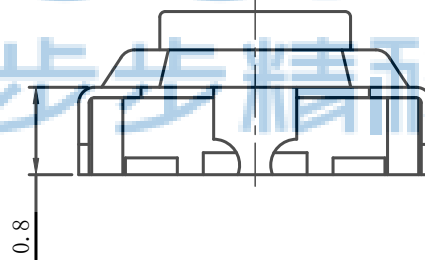
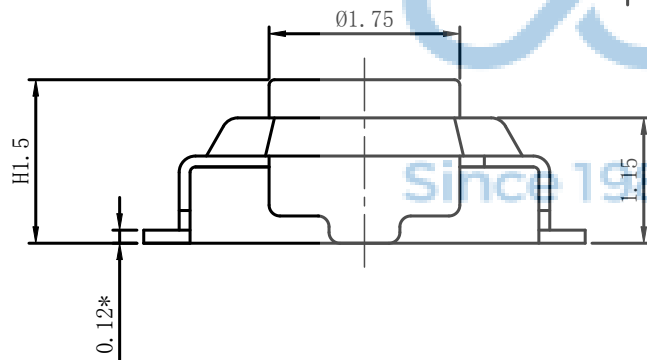
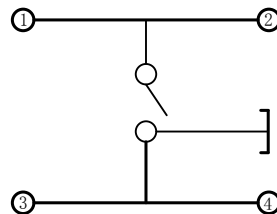

原理图



序号	名称	材料	数量	备注
E	盖板	不锈钢0.1	1	酸洗
D	按钮	LCP 黑	1	
C	簧片	进口不锈钢覆银	2	
B	底座	LCP 黑	1	
A	卡件	磷铜0.1	1	镀银

THIS DOCUMENT IS THE SOLE PROPERTY OF BBJconn Technology Co.,Ltd. Corporation AND SHOULD NOT BE USED IN WHOLE OR IN PART WITHOUT PRIOR WRITTEN PERMISSION. PDWG:NO: 0278-1

深圳市步步精科技有限公司

NAME: 轻触开关 3x3x1.5 贴片 不锈钢双弹片 黑柄 260gf

PJ. NO.: TS.19.01-11-28-01

SIZE: A4 DRW NO.:

FINISH: SEE NOTES MAT'L.: SEE NOTES

SCALE: N/A REV.: AO UNIT: mm PAGE: 1/2

APPD. JM_Zheng

CHKD. TSP

DR. LYX

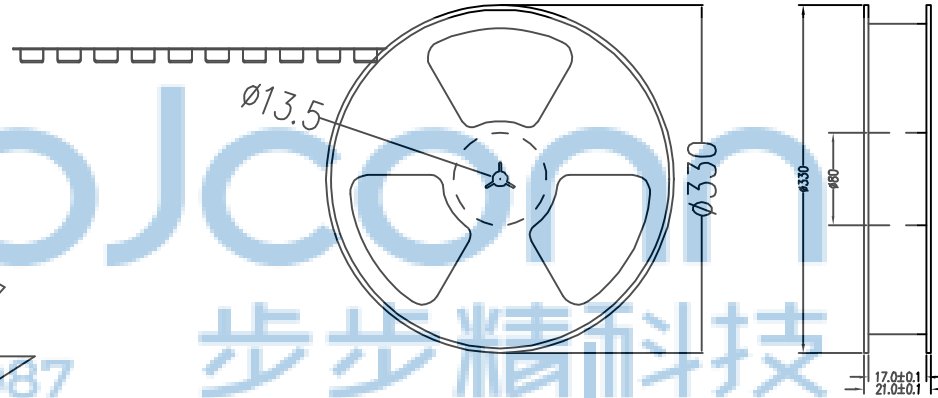
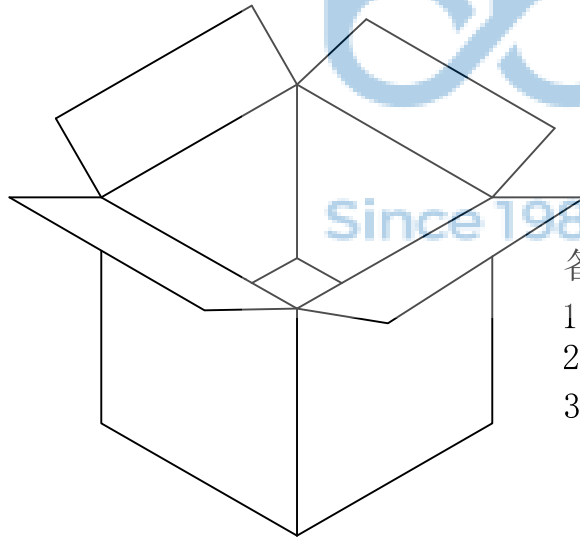
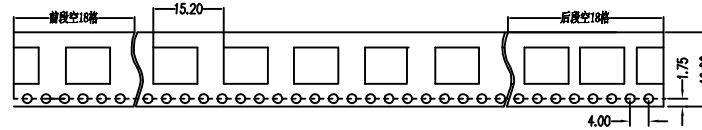
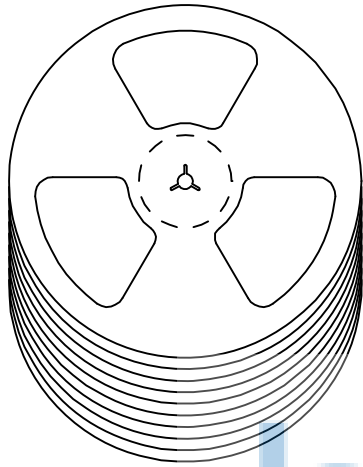

备注:

1. 包装数量: 4000/PCS
2. 包装袋长度: 每卷前后各空10-20个空格, 中间包装。
3. 材质:
载体: 聚丙烯 (PS), 阻抗 $10^{6-9} \Omega$
上带: 聚乙烯 (PET), 阻抗 $10^{6-11} \Omega$
卷盘: 聚苯乙烯。

纸箱规格: 345*345*23MM

纸箱规格: 345*345*35MM

THIS DOCUMENT IS THE SOLE PROPERTY OF BBJconn Technology Co.,Ltd Corporation AND SHOULD NOT BE USED IN WHOLE OR IN PART WITHOUT PRIOR WRITTEN PERMISSION.		深圳市步步精科技有限公司	
.X: ±0.38 .XX: ±0.25 .XXX: ±0.13		X': ±3' .X': ±2' .XX': ±1'	
APPD. JM_Zheng		NAME: 3x3x1.5 260g	
CHKD. TSP		P.J. NO.: TS.19.01-11-28-01	
DR. LYX		SIZE: A4 DRW NO.:	
PDWG.NO: 0278-1		FINISH: SEE NOTES MAT'L.: SEE NOTES	
		SCALE: N/A REV.: A0 UNIT: mm PAGE: 2/2	