

| REV. | ECN NO | CONTENT | DATE | ENGINEER |
|------|--------|---------|------|----------|
| A0 | | | | |

Specification of KFC Flip Switch

1. Contact; Mechanical Contact
2. Rating; Dc12v50mA
3. Travel; 0.25+0.1M/M
4. Operating Force; 160/260 ± 30gf
5. Contact Resistance; 30mΩ Max
6. Life; 80000 Cycles Mim

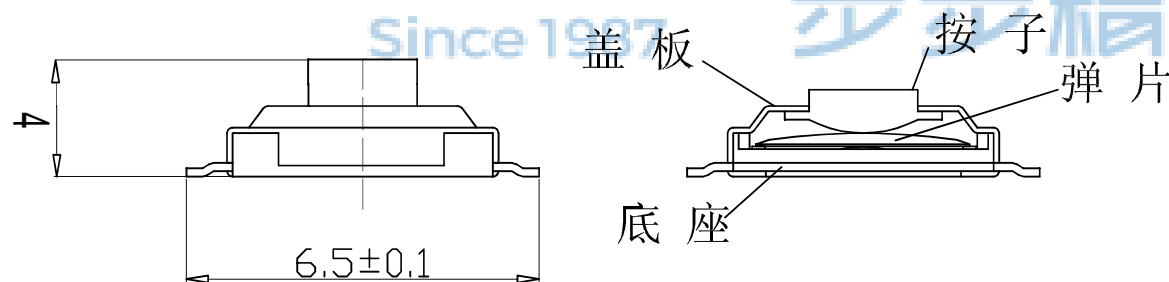
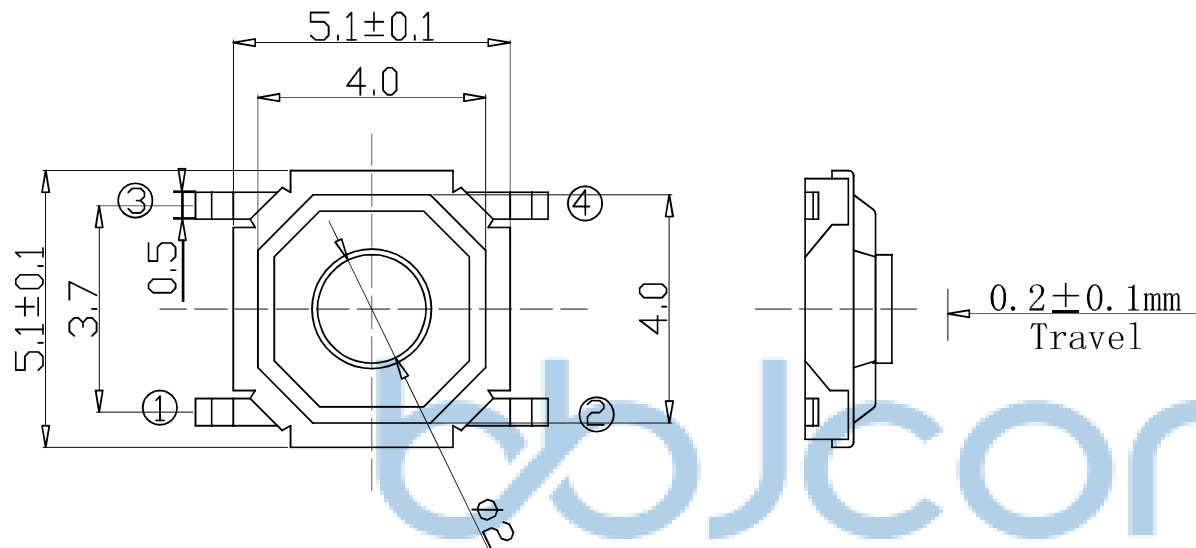

| 4 | 弹片 | 1 | 0.05mm 不锈钢 | 银白色 |
|----|----|----|-----------------|-------|
| 3 | 按子 | 1 | 黄铜 | 黄色 |
| 2 | 盖板 | 1 | 0.1mm 不锈钢 | 镀银 |
| 1 | 底座 | 1 | 0.15mm 黄铜与 PA66 | 黑色与镀银 |
| 序号 | 名称 | 数量 | 材料 | 镀涂/颜色 |

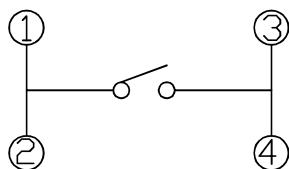

| | | | | | |
|---|--|----------------------------------|-----------------------------------|----------------------------|--|
| THIS DOCUMENT IS THE SOLE PROPERTY OF BBJconn Technology Co., Ltd. Corporation AND SHOULD NOT BE USED IN WHOLE OR IN PART WITHOUT PRIOR WRITTEN PERMISSION. PDWG.No./ 0278-1 | 深圳市步步精科技有限公司 | | NAME: 轻触开关 4x4x4 铜头贴片 不锈钢弹片 260GF | | |
| | .X: ±0.38 .XX: ±0.25 .XXX: ±0.13 | X': ±3' X'': ±2' X''': ±1' | APPD. JM_Zheng | PJ. NO.: TS.03.09-11-38-01 | SIZE: A4 DRW NO.: |
| | CHKD. TSP | DR. LYX | FINISH: SEE NOTES | MAT'L.: SEE NOTES | SCALE: N/A REV.: A3 UNIT: mm PAGE: 1/1 |
| | | | | | |

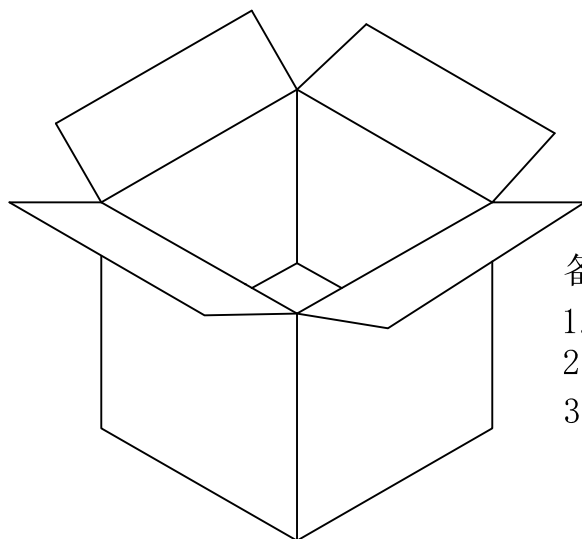
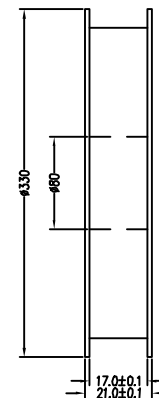
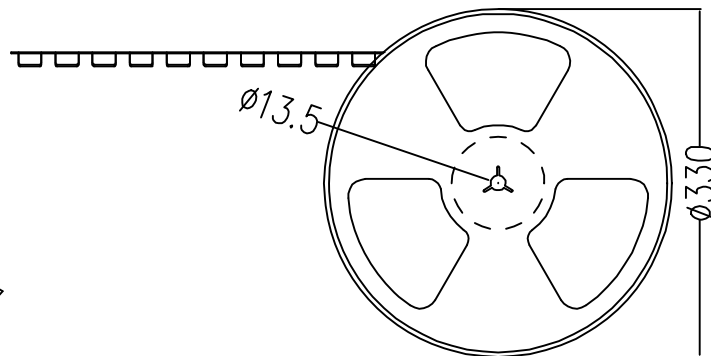
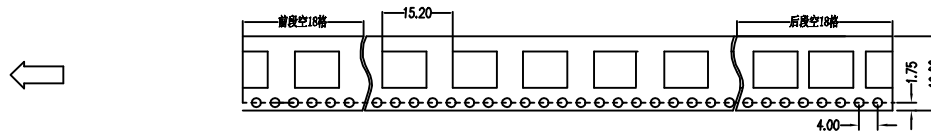
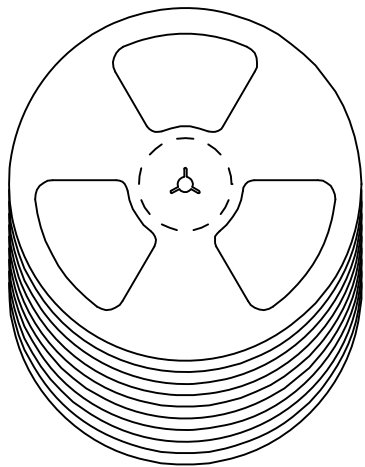

备注:

1. 包装数量: 2000/PCS/卷, 10卷/箱。
2. 包装袋长度: 每卷前后各空10-20个空格, 中间包装。
3. 材质:
载体: 聚丙烯 (PS), 阻抗 $10^{6-9} \Omega$
上带: 聚乙烯 (PET), 阻抗 $10^{6-11} \Omega$
卷盘: 聚苯乙烯。

纸箱规格: 345*345*23MM

纸箱规格: 345*345*35MM

| | | | |
|---|----------|--|--|
| THIS DOCUMENT IS THE SOLE PROPERTY OF BBJconn Technology Co.,Ltd Corporation AND SHOULD NOT BE USED IN WHOLE OR IN PART WITHOUT PRIOR WRITTEN PERMISSION. | | 深圳市步步精科技有限公司 | |
| .X: ±0.38 .XX: ±0.25 .XXX: ±0.13 | | X': ±3" X'': ±2" X'X': ±1" | |
| APPD. | JM_Zheng | NAME: Çá ¥¿ª¹Ø 4x4x4 í-í-ü/Æ-²»Đâ, Öµ/Æ- 260GF | |
| CHKD. | TSP | P.J. NO.: TS.03.09-11-38-01 | |
| DR. | LYX | SIZE: A4 DRW NO.: | |
| PDWG.NO: 0278-1 | | FINISH: SEE NOTES MAT'L.: SEE NOTES | |
| | | SCALE: N/A REV.: A3 UNIT: mm PAGE: 1/1 | |