

REV.	ECN NO	CONTENT	DATE	ENGINEER
A0		Initial release	/	SGF

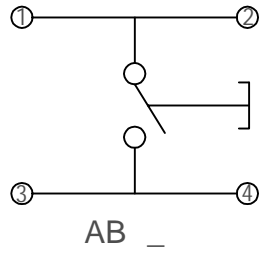

- 技术要求:
1. 零部件表面光洁无划伤, 水花, 变形, 影响外观及性能等缺陷。
 2. 额定电流: 50mA. 12V DC, 绝缘电阻100MΩ min, 100V DC, 介电强度250V AC for 1min, 接触电阻100mΩ max。
 3. 开关手感明显, 档位清晰可靠, 无卡滞现象, 消除外力后, 应能快速回位。

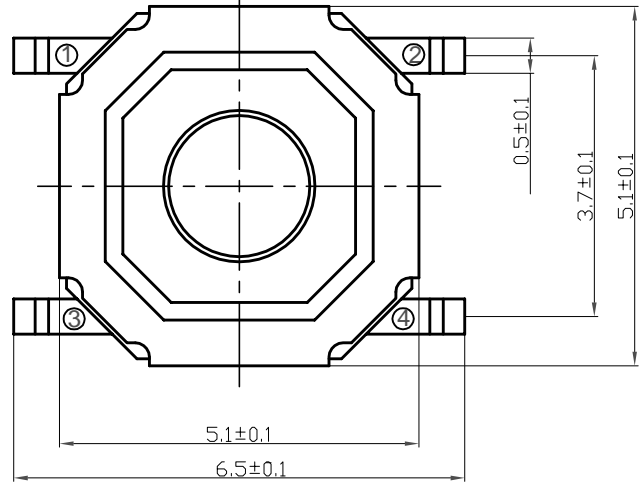
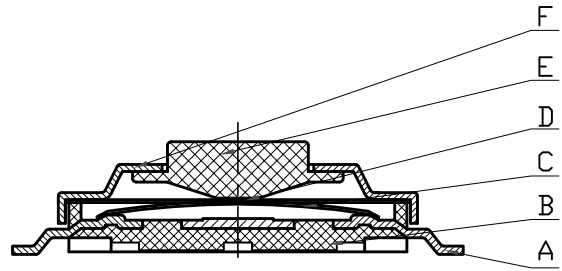
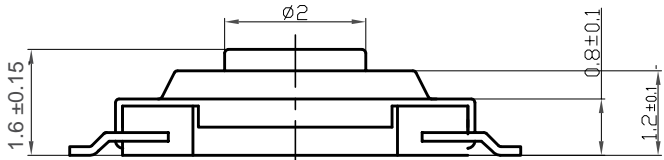
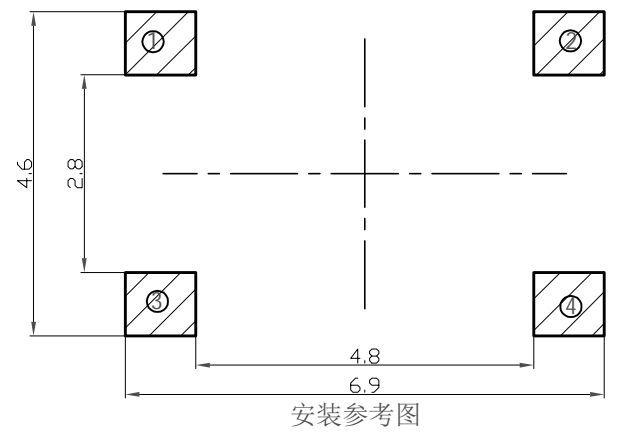

5	盖Q	KLM 0.13	1	IJ
4	ST	b 铜	1	IJ
3	UV	NOKLMPH	1	8c
2	WX	LCPR	1	
1	3 件	! 0.15	1	GH
a^] 料	\	YZ

THIS DOCUMENT IS THE SOLE PROPERTY OF BBJconn Technology Co.,Ltd. Corporation AND SHOULD NOT BE USED IN WHOLE OR IN PART WITHOUT PRIOR WRITTEN PERMISSION.

PDWG.NO: 0278-1

APPD. JM_Zheng

CHKD. LYX

DR. SGF

NAME: 盖Q

PJ. NO.: TS.03.02-12-38-02

SIZE: A4 DRW NO.:

FINISH: SEE NOTES MAT'L.: SEE NOTES

SCALE: N/A REV.: A0 UNIT: mm PAGE: 1/2

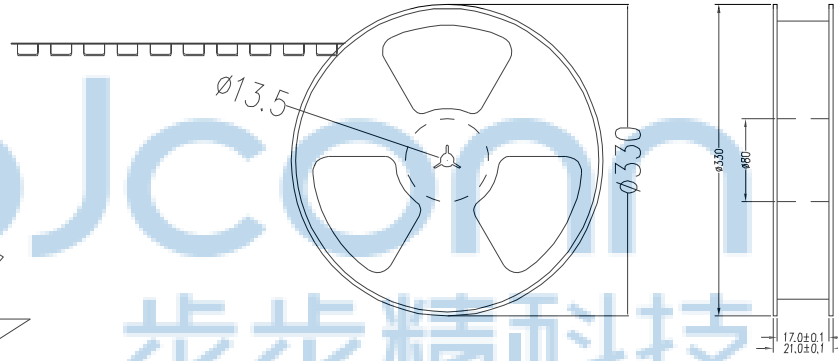
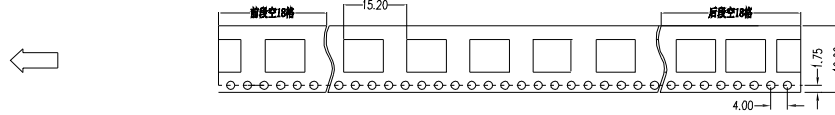
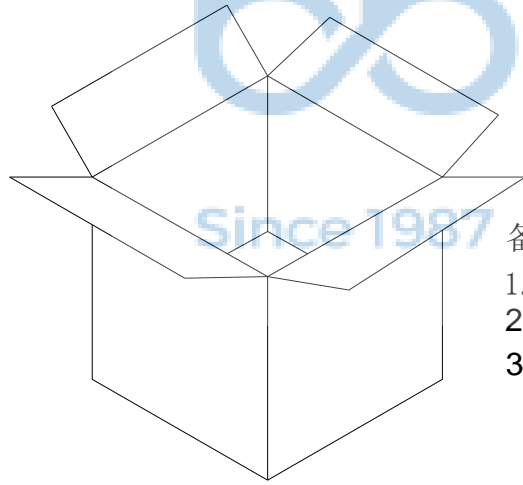
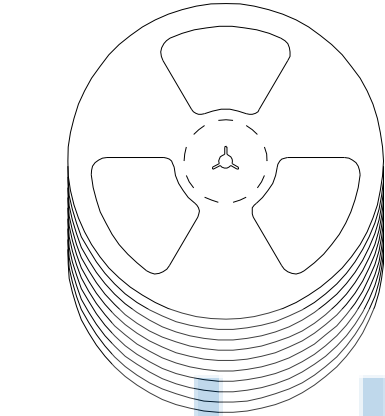

备注:

1. 包装数量: 4000/PCS/ (10 /) * 15 /箱。
2. \$ %, - . # / 0 1 2 3 10-204 3 5 (6 7 \$ % +
3. 8 9 #
: ; # < = > ? PS@ (A B 10⁶⁻⁹ Ω
上带: 聚乙烯 (PET), A B 10⁶⁻¹¹C
G # < H F > +
I) J 5 # 345*345*23MM
I) J 5 # 345*345*35MM

THIS DOCUMENT IS THE SOLE PROPERTY OF BBJconn Technology Co.,Ltd. Corporation AND SHOULD NOT BE USED IN WHOLE OR IN PART WITHOUT PRIOR WRITTEN PERMISSION.		PDWG.NO: 0278-1		DR. SGF		深圳市步步精科技有限公司 .X: ±0.38 .XX: ±0.25 .XXX: ±0.13 X': ±3' .X': ±2' .XX': ±1' NAME: 轻触开关 4x4x1.6 铜头贴片 不锈钢弹片 160G 全膜热封编带 APPD. JM_Zheng CHKD. LYX PJ. NO.: TS.03.02-12-38-02 SIZE: A4 DRW NO.: FINISH: SEE NOTES MAT'L.: SEE NOTES SCALE: N/A REV.: A0 UNIT: mm PAGE: 2/2	
--	--	-----------------	--	---------	--	--	--