

REV.	ECN NO.	CONTENT	DATE	ENGINEER
A0		Initial release	/	SGF

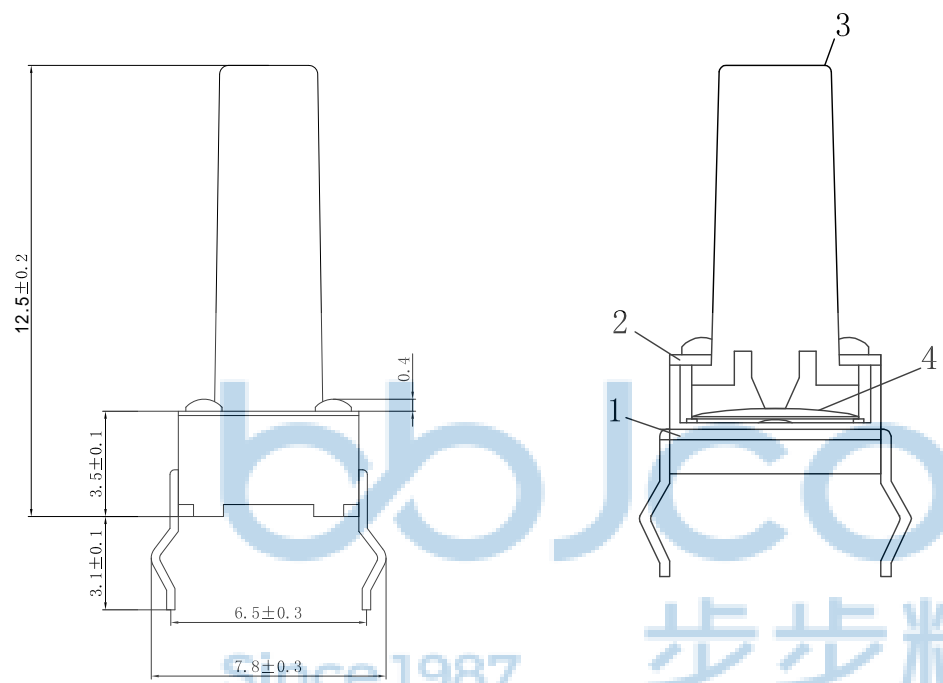

主要技术参数	1	操作行程	0.25±0.1mm
	2	额定电压、电流	DC12V/50mA
	3	接触电阻	30mΩ(max)
	4	绝缘电阻	100MΩ(min)
	5	耐 压	250V AC/1min
	6	动 作 力	160/260±30gf
	7	使用寿命	80000次
	8	尺 寸	未注公差均按 GB/T1804-2000

序号	名 称	数量	材 料	镀涂/颜色
1	底 座	1	黄铜与PPA	黑色与镀银
2	盖 板	1	铁皮	镀银
3	按 钮	1	PPA	黑色
4	弹 片	1	不锈钢	镀银/白色



THIS DOCUMENT IS THE SOLE PROPERTY OF BBJconn Technology Co.,Ltd. Corporation AND SHOULD NOT BE USED IN WHOLE OR IN PART WITHOUT PRIOR WRITTEN PERMISSION.
PDWG.NO: 0013-1

深圳市步步精科技有限公司

NAME: 轻触开关 6x6x12.5 直插 不锈钢弹片 260G 袋装

APPD. JM_Zheng

CHKD. LYX

DR. SGF

PJ. NO.: TS.01.28-21-31-01

SIZE: A4 DRW NO.:

FINISH: SEE NOTES MAT'L.: SEE NOTES

SCALE: N/A REV.: A0 UNIT: mm PAGE: 1/2

REV.	ECN NO	CONTENT	DATE	ENGINEER
A0		Initial release	/	SGF

PE袋规格:***X*** (以实际出货为准)

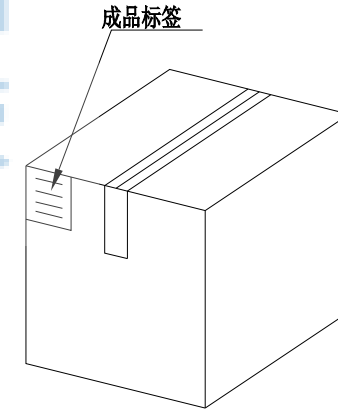
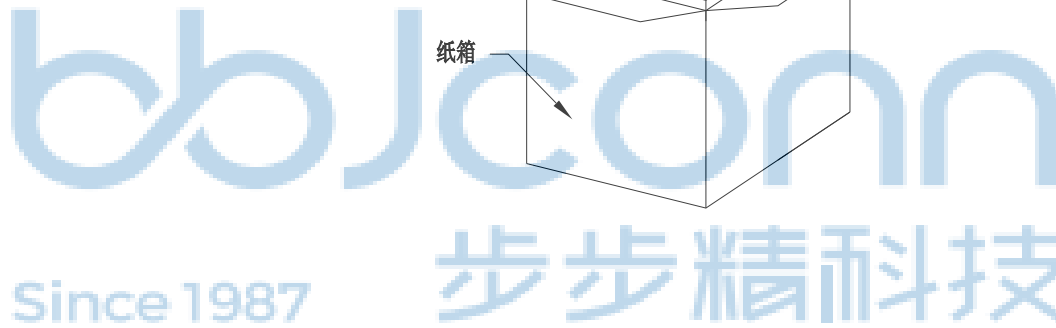
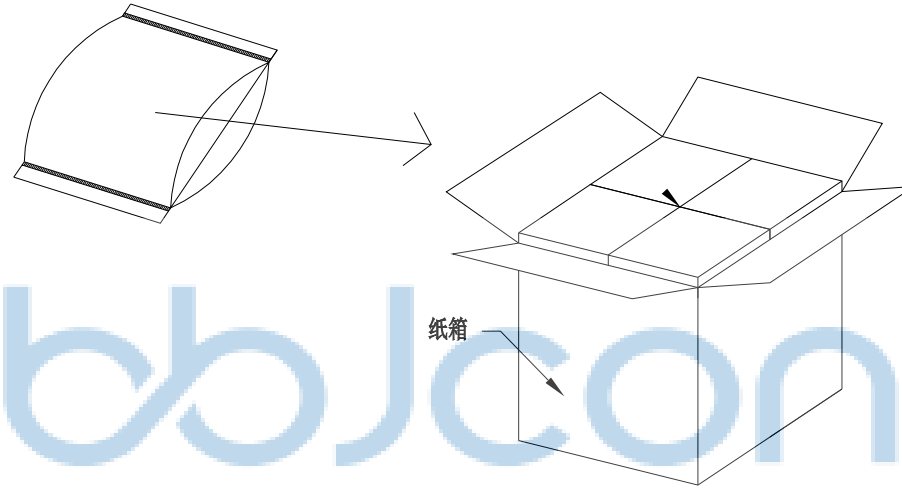

1. 包装要求:

- 1.1 每PE袋包装 1000 pcs;
- 1.2 每1袋放一小纸盒;
- 1.3 每20个小纸盒放一个纸箱, 共计20000PCS
- 1.4 纸箱外贴上标签



THIS DOCUMENT IS THE SOLE PROPERTY OF BBJconn Technology Co.,Ltd. Corporation AND SHOULD NOT BE USED IN WHOLE OR IN PART WITHOUT PRIOR WRITTEN PERMISSION.		深圳市步步精科技有限公司 .X: ±0.38 X': ±3' NAME: .XX: ±0.25 X'': ±2' 轻触开关 6x6x12.5 直插 不锈钢弹片 260G 袋装 .XXX: ±0.13 XX': ±1'	
APPD.	JM_Zheng	PJ. NO.: TS.01.28-21-31-01 SIZE: A4 DRW NO.:	
CHKD.	LYX		
PDWG.NO:	0013-1	DR.	SGF
		FINISH: SEE NOTES	MAT'L.: SEE NOTES
		SCALE: N/A	REV.: A0 UNIT: mm PAGE: 2/2