

REV.	ECN NO.	CONTENT	DATE	ENGINEER
A0		Initial release	/	SGF

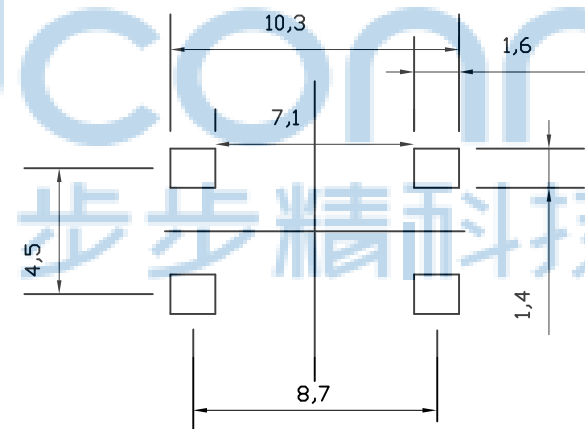
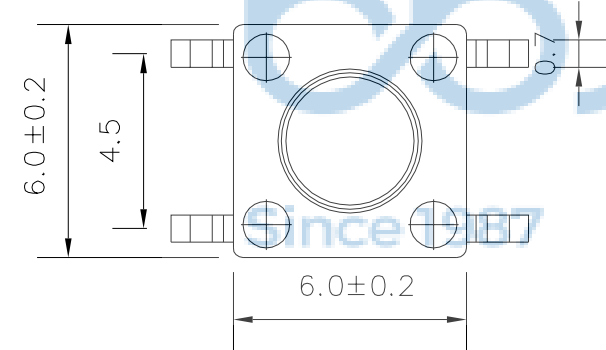
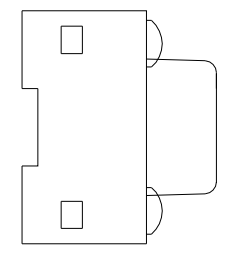
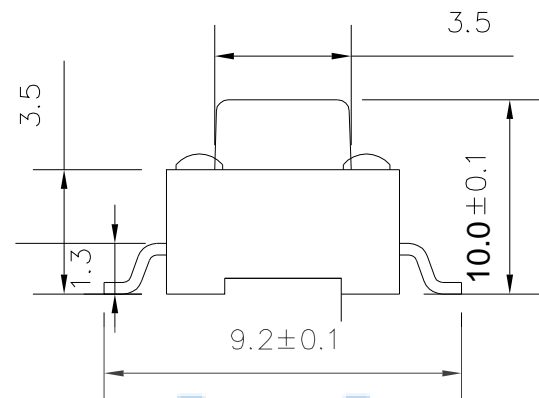

安装尺寸

主要技术参数	1	操作行程	0.25±0.1mm
	2	额定电压、电流	DC12V/50mA
	3	接触电阻	30mΩ(max)
	4	绝缘电阻	100MΩ(mi n)
	5	耐 压	250V AC/1mi n
	6	动 作 力	160/260 ± 30gf
	7	使用寿命	80000次
	8	尺 寸	未注公差均按 GB/T1804—2000

4	弹片	1	不锈钢 SUS304	镀银/白色
3	按子	1	PPA	黑色
2	盖板	1	铁 SPCC	镀银/白色
1	底座	1	黄铜与 PPA (H65)	黑色与镀银
序号	名称	1	材料	镀涂/颜色



THIS DOCUMENT IS THE SOLE PROPERTY OF BBJconn Technology Co.,Ltd. Corporation AND SHOULD NOT BE USED IN WHOLE OR IN PART WITHOUT PRIOR WRITTEN PERMISSION.

PDWG.NO: 0013-1

APPD. JM_Zheng
CHKD. LYX
DR. SGF

NAME: 轻触开关 6x6x10 贴片 不锈钢弹片 160G 9.2脚

PJ. NO.: TS.01.23-12-31-01
SIZE: A4 DRW NO.:
FINISH: SEE NOTES MAT'L.: SEE NOTES
SCALE: N/A REV.: A0 UNIT: mm PAGE: 1/2

深圳市步步精科技有限公司

REV.	ECN NO	CONTENT	DATE	ENGINEER
A0		Initial release	/	SGF

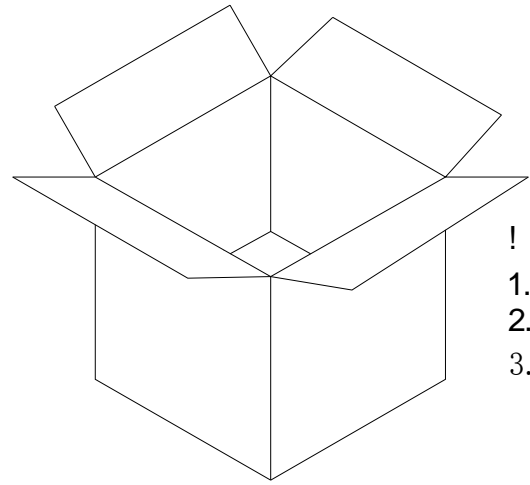
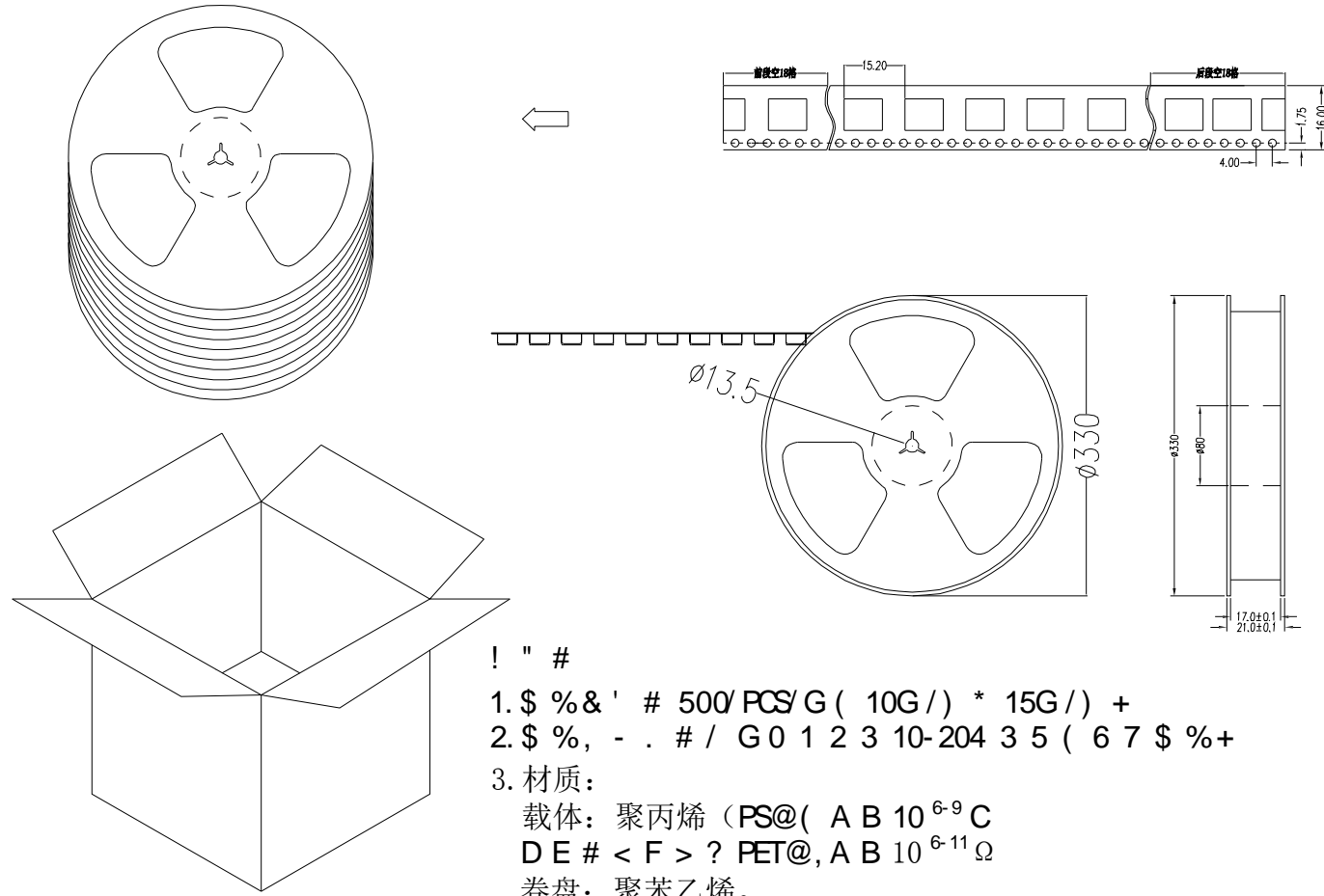

! " #
 1. \$ % & ' # 500/PCS/G (10G /) * 15G /) +
 2. \$ % , - . # / G 0 1 2 3 10-204 3 5 (6 7 \$ % +
 3. 材质:
 载体: 聚丙烯 (PS@ (A B 10⁶⁻⁹ C
 D E # < F > ? PET@, A B 10⁶⁻¹¹ Ω
 卷盘: 聚苯乙烯。
 纸箱规格: 345*345*23MM
 I) J 5 # 345*345*35MM

THIS DOCUMENT IS THE SOLE PROPERTY OF BBJconn Technology Co.,Ltd. Corporation AND SHOULD NOT BE USED IN WHOLE OR IN PART WITHOUT PRIOR WRITTEN PERMISSION.		 深圳市步步精科技有限公司	
PDWG.NO: 0013-1		APPD. JM_Zheng CHKD. LYX DR. SGF	NAME: Çá ¥¿ a1Ø 6x6x10 ìùÆ-²»Đâ, ÖµÆ- 160G 9.2½Ä PJ. NO.: TS.01.23-12-31-01 SIZE: A4 DRW NO.: FINISH: SEE NOTES MAT'L.: SEE NOTES SCALE: N/A REV.: A0 UNIT: mm PAGE: 2/2