

REV.	ECN NO.	CONTENT	DATE	ENGINEER
A0		Initial release	/	SGF

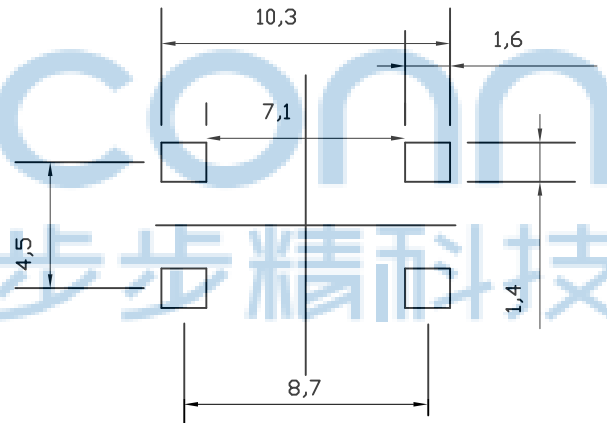
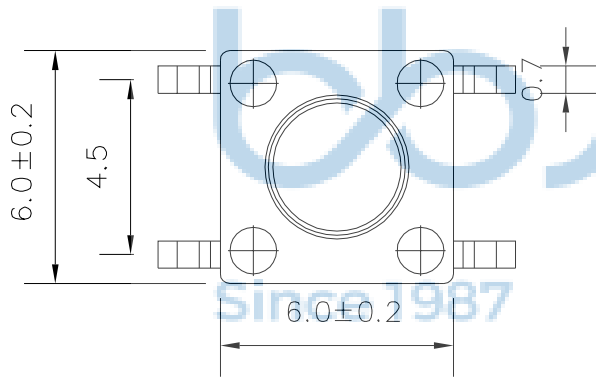
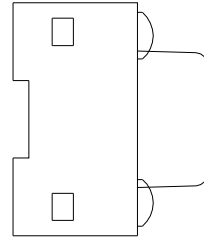
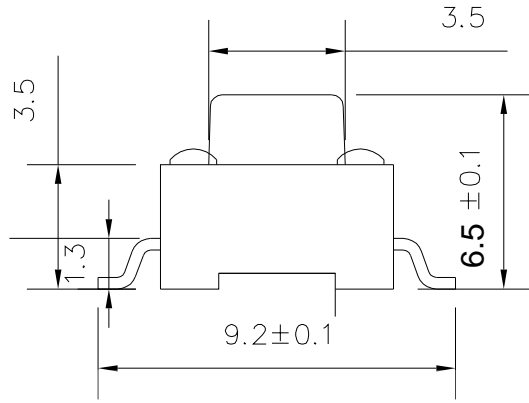

安装尺寸

主要技术参数	1	操作行程	0.25±0.1mm
	2	额定电压、电流	DC12V/50mA
	3	接触电阻	30mΩ(max)
	4	绝缘电阻	100MΩ(mi n)
	5	耐 压	250V AC/1mi n
	6	动 作 力	160/260 ± 30gf
	7	使用寿命	80000次
	8	尺 寸	未注公差均按 GB/T1804—2000

4	弹片	1	不锈钢 SUS304	镀银/白色
3	接子	1	PPA	黑色
2	盖板	1	铁 SPCC	镀银/白色
1	底座	1	黄铜与 PPA (H65)	黑色与镀银
序号	名称	1	材料	镀涂/颜色



THIS DOCUMENT IS THE SOLE PROPERTY OF BBJconn Technology Co.,Ltd. Corporation AND SHOULD NOT BE USED IN WHOLE OR IN PART WITHOUT PRIOR WRITTEN PERMISSION.

PDWG.NO: 0013-1

APPD. JM\_Zheng  
CHKD. LYX  
DR. SGF

NAME: 轻触开关 6x6x6.5 贴片 不锈钢弹片 160G 9.2脚

PJ. NO.: TS.01.16-12-31-01  
SIZE: A4 DRW NO.:

FINISH: SEE NOTES MAT'L.: SEE NOTES  
SCALE: N/A REV.: A0 UNIT: mm PAGE: 1/2

深圳市步步精科技有限公司

REV.	ECN NO	CONTENT	DATE	ENGINEER
A0		Initial release	/	SGF

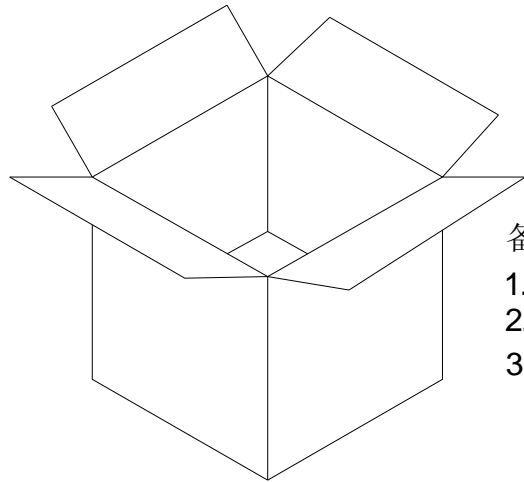
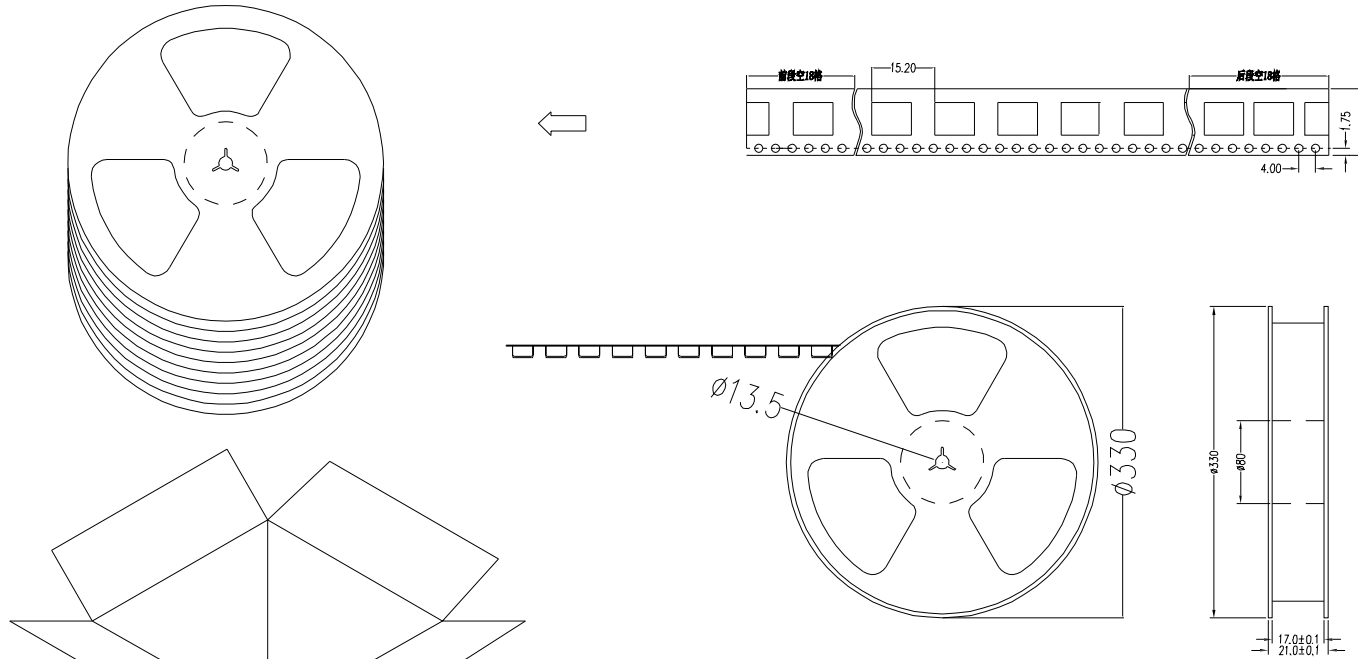

备注:

1. \$ % & ' # 900/PCS/G ( 10G / ) \* 15G / ) +
2. 包装袋长度: 每卷前后各空10-20个空格, 中间包装。

3. 8 9 #  
: ; # < = > ? PS@ ( A B 10<sup>6-9</sup> C  
D E # < F > ? PET@, 阻抗 10<sup>6-11</sup> Ω  
卷盘: 聚苯乙烯。

纸箱规格: 345\*345\*23MM

I ) J 5 # 345\*345\*35MM

THIS DOCUMENT IS THE SOLE PROPERTY OF BBJconn Technology Co.,Ltd. Corporation AND SHOULD NOT BE USED IN WHOLE OR IN PART WITHOUT PRIOR WRITTEN PERMISSION.		 <b>深圳市步步精科技有限公司</b>	
PDWG.NO: 0013-1		APPD. JM_Zheng CHKD. LYX DR. SGF	NAME: Ćá'ŕ; 81Ø 6x6x6.5 ìù/Æ- 2»Đâ, Öp̄/Æ- 160G 9.2½Å PJ. NO.: TS.01.16-12-31-01 SIZE: A4   DRW NO.: FINISH: SEE NOTES   MAT'L.: SEE NOTES SCALE: N/A   REV.: A0   UNIT: mm   PAGE: 2/2