

### 技术参数

1. 额定电流: 50mA 12V DC
2. 接触电阻: 100毫欧
3. 行程: 0.15±0.05mm
4. 绝缘电阻: 100兆欧
5. 抗电强度: 250v 50Hz 1Min

|    |          |          |          |
|----|----------|----------|----------|
| 接力 | 200±40gf | 260±50gf | 300±60gf |
| 寿命 | 8万次      | 8万次      | 8万次      |

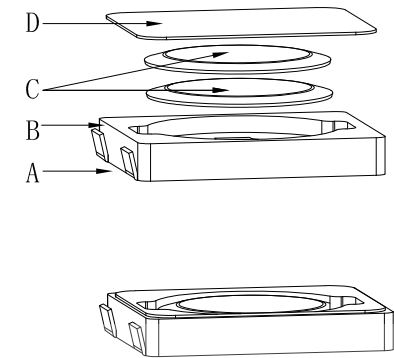
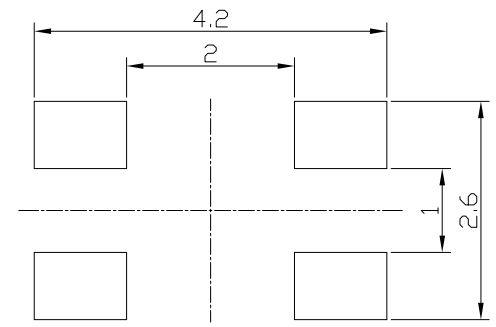
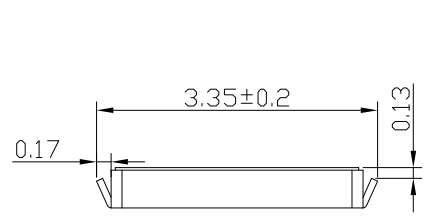

P C B 参考图

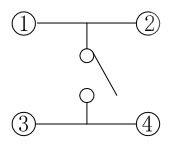
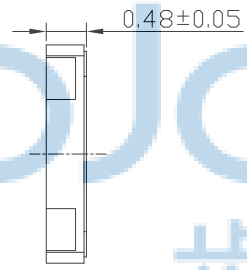
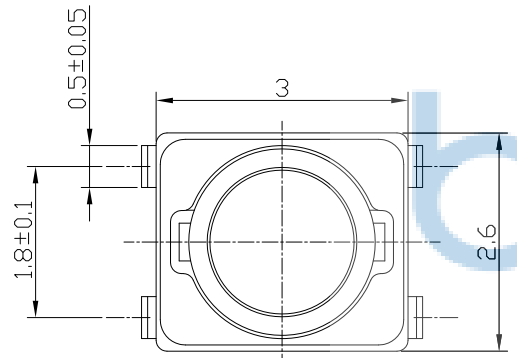

电器原理图



|    |     |        |    |    |
|----|-----|--------|----|----|
| E  | 按键点 | 聚锌亚胺   | 1  |    |
| D  | 防尘膜 | pi膜    | 1  | 黄色 |
| C  | 簧片  | 不锈钢覆银  | 2  |    |
| B  | 基座  | LCP    | 1  | 清洗 |
| A  | 卡件  | 磷铜0.08 | 1  | 镀银 |
| 序号 | 名称  | 材料     | 数量 | 备注 |

|  |  |  |  |   |
|--|--|--|--|---|
| THIS DOCUMENT IS THE SOLE PROPERTY OF BBJconn Technology Co.,Ltd. Corporation AND SHOULD NOT BE USED IN WHOLE OR IN PART WITHOUT PRIOR WRITTEN PERMISSION. |  | 深圳市步步精科技有限公司<br>.X: ±0.38 .XX: ±0.25 .XXX: ±0.13<br>X': ±3' .X': ±2' .XX': ±1'   |  | NAME: 轻触开关 2.6x3x0.48 U型脚 薄片 不带点 不锈钢双弹片 260GF<br>APPD. JM_Zheng<br>CHKD. LYX<br>DR. SGF |
| PDWG.NO: 0415-1  |  | PJ. NO.: TS.40.73-11-3Z-01<br>SIZE: A4 DRW NO.:<br>FINISH: SEE NOTES MAT'L.: SEE NOTES<br>SCALE: N/A REV.: A0 UNIT: mm PAGE: 1/2 |  |   |

| REV. | ECN NO | CONTENT         | DATE | ENGINEER |
|------|--------|-----------------|------|----------|
| A0   |        | Initial release | /    | SGF      |

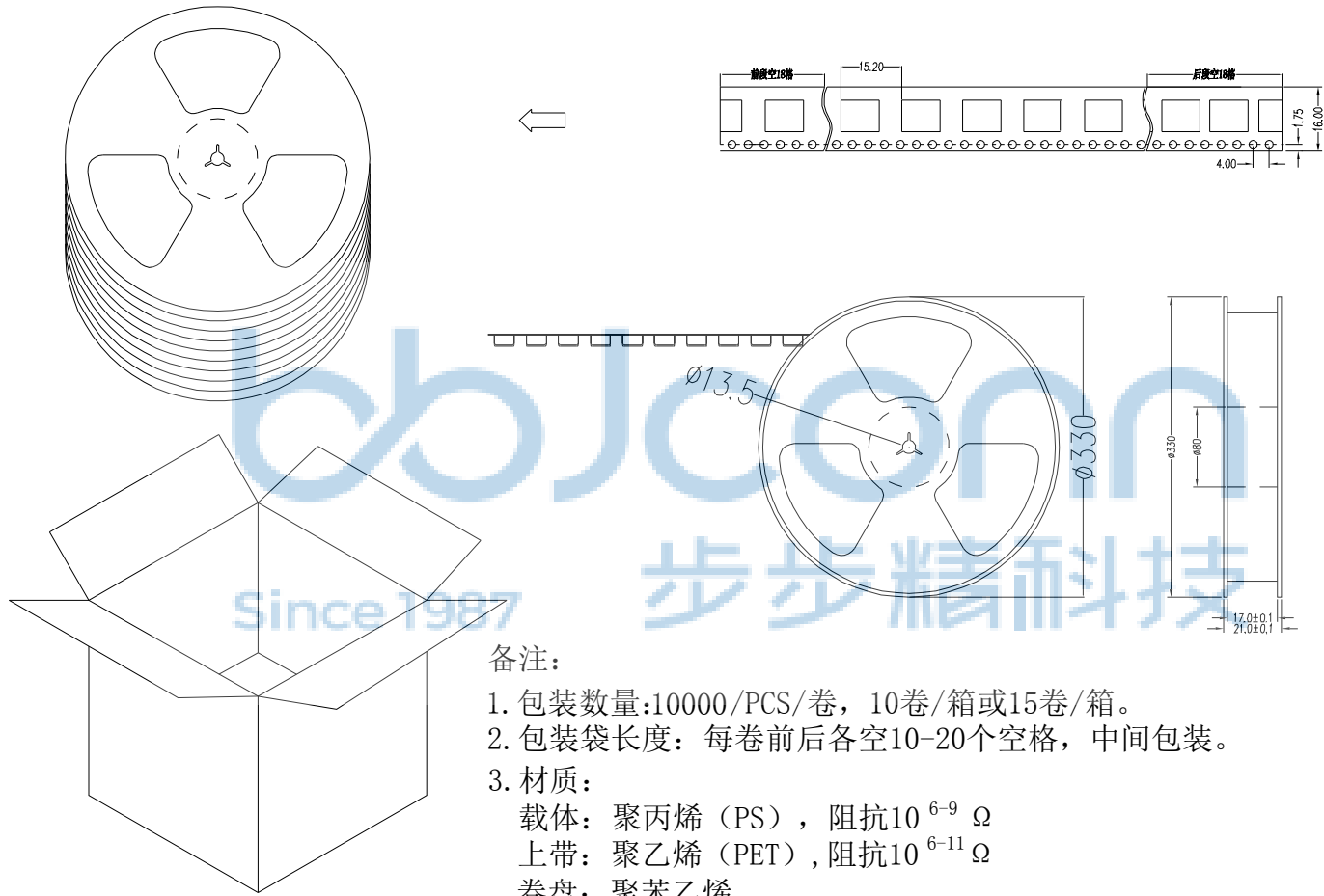

备注：  
 1. 包装数量:10000/PCS/卷，10卷/箱或15卷/箱。  
 2. 包装袋长度：每卷前后各空10-20个空格，中间包装。  
 3. 材质：  
 载体：聚丙烯（PS），阻抗 $10^{6-9} \Omega$   
 上带：聚乙烯（PET），阻抗 $10^{6-11} \Omega$   
 卷盘：聚苯乙烯。  
 纸箱规格：345\*345\*23MM  
 纸箱规格：345\*345\*35MM

|  |          |   |  |
|--|----------|---|--|
| THIS DOCUMENT IS THE SOLE PROPERTY OF BBJconn Technology Co.,Ltd. Corporation AND SHOULD NOT BE USED IN WHOLE OR IN PART WITHOUT PRIOR WRITTEN PERMISSION. |          | 深圳市步步精科技有限公司                                    |  |
| .X: $\pm 0.38$<br>.XX: $\pm 0.25$<br>.XXX: $\pm 0.13$  |          | X': $\pm 3'$<br>.X': $\pm 2'$<br>.XX': $\pm 1'$ |  |
| APPD.  | JM_Zheng | NAME: 轻触开关 2.6x3X0.48 U型脚 薄片 不带点 不锈钢双弹片 260GF   |  |
| CHKD.  | LYX      | PJ. NO.: TS.40.73-11-3Z-01                      |  |
| DR.  | SGF      | SIZE: A4 DRW NO.:                               |  |
| PDWG.NO: 0415-1  |          | FINISH: SEE NOTES MAT'L.: SEE NOTES             |  |
|  |          | SCALE: N/A REV.: A0 UNIT: mm PAGE: 2/2          |  |