

REV.	ECN NO	CONTENT	DATE	ENGINEER
A0				

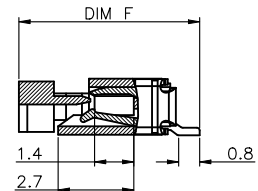

- Note:**
- Material:**
 - Housing: thermoplastic high temp.UL94V-0; Color: natural.
 - Latch: thermoplastic high temp.UL94V-0; Color: black.
 - Terminal: copper alloy.
 - Fitting Nail: copper alloy.
 - Finish:**
 - Terminal:
Underplating: Au/matt Tin overall.
 - Fitting Nail:
Underplating: matt Tin overall.
 - Product must comply HF RoHS specification.

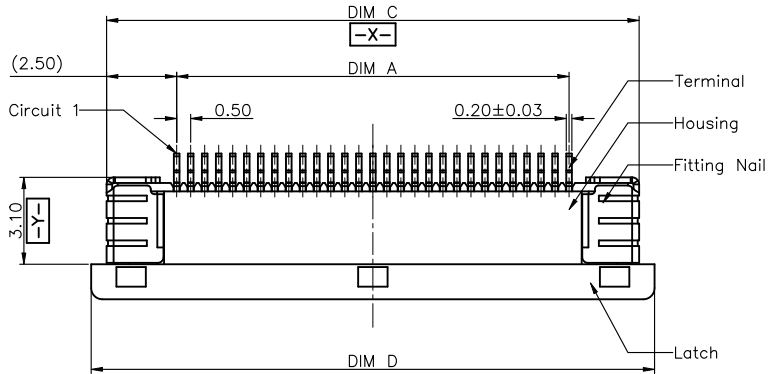

CKTS	DIM A	DIM B	DIM C	DIM D	DIM E	DIM F
4	1.50	2.60	6.50	7.60		
5	2.00	3.10	7.00	8.10		
6	2.50	3.60	7.50	8.60		
7	3.00	4.10	8.00	9.10		
8	3.50	4.60	8.50	9.60		
9	4.00	5.10	9.00	10.10		
10	4.50	5.60	9.50	10.60		
11	5.00	6.10	10.00	11.10		
12	5.50	6.60	10.50	11.60		
13	6.00	7.10	11.00	12.10		
14	6.50	7.60	11.50	12.60		
15	7.00	8.10	12.00	13.10		
16	7.50	8.60	12.50	13.60		
17	8.00	9.10	13.00	14.10		
18	8.50	9.60	13.50	14.60		
19	9.00	10.10	14.00	15.10	5.20	6.45
20	9.50	10.60	14.50	15.60		
21	10.00	11.10	15.00	16.10		
22	10.50	11.60	15.50	16.60		
23	11.00	12.10	16.00	17.10		
24	11.50	12.60	16.50	17.60		
25	12.00	13.10	17.00	18.10		
26	12.50	13.60	17.50	18.60		
27	13.00	14.10	18.00	19.10		
28	13.50	14.60	18.50	19.60		
29	14.00	15.10	19.00	20.10		
30	14.50	15.60	19.50	20.60		
31	15.00	16.10	20.00	21.10		
32	15.50	16.60	20.50	21.60		
33	16.00	17.10	21.00	22.10		
34	16.50	17.60	21.50	22.60		
35	17.00	18.10	22.00	23.10		
36	17.50	18.60	22.50	23.60		
37	18.00	19.10	23.00	24.10		
38	18.50	19.60	23.50	24.60		
39	19.00	20.10	24.00	25.10		
40	19.50	20.60	24.50	25.60		
41	20.00	21.10	25.00	26.10		
42	20.50	21.60	25.50	26.60		
43	21.00	22.10	26.00	27.10		
44	21.50	22.60	26.50	27.60		
45	22.00	23.10	27.00	28.10		
46	22.50	23.60	27.50	28.60		
47	23.00	24.10	28.00	29.10	5.75	7.00
48	23.50	24.60	28.50	29.60		
49	24.00	25.10	29.00	30.10		
50	24.50	25.60	29.50	30.60		
51	25.00	26.10	30.00	31.10		
52	25.50	26.60	30.50	31.60		
53	26.00	27.10	31.00	32.10		
54	26.50	27.60	31.50	32.60		
55	27.00	28.10	32.00	33.10		
56	27.50	28.60	32.50	33.60		
57	28.00	29.10	33.00	34.10		
58	28.50	29.60	33.50	34.60		
59	29.00	30.10	34.00	35.10		
60	29.50	30.60	34.50	35.60		

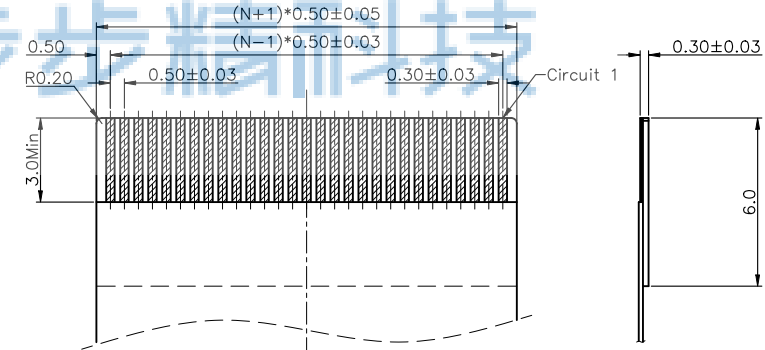
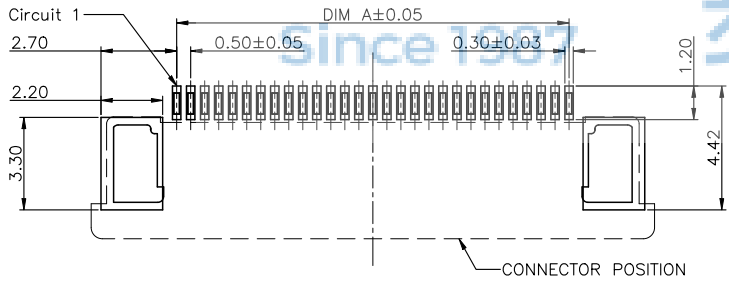
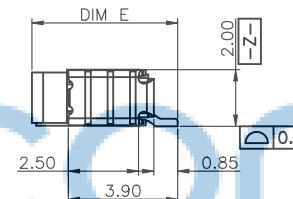
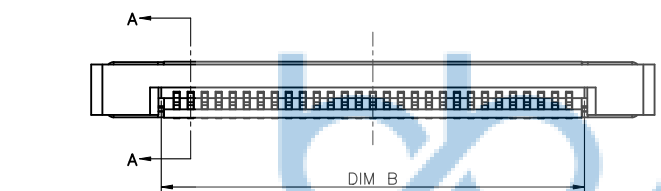

THIS DOCUMENT IS THE SOLE PROPERTY OF BBJconn Technology Co., Ltd. Corporation AND SHOULD NOT BE USED IN WHOLE OR IN PART WITHOUT PRIOR WRITTEN PERMISSION. PDWG,NO: 0167-1

深圳市步步精科技有限公司

NAME: FPC 0.5-22P 抽拉下接 H=2.0 (AFC07)

APPD. JM_Zheng

CHKD. LYX

DR. TSP

PJ. NO.: PC.02.02-32-2042

SIZE: A4 DRW NO.:

FINISH: SEE NOTES MAT'L.: SEE NOTES

SCALE: N/A REV.: A0 UNIT: mm PAGE: 1/2

REV.	ECN NO	CONTENT	DATE	ENGINEER
A0				

NOTES:

1. 10 SPROCKET HOLE PITCH CUMULATIVE TOLERANCE.±0.20mm
2. CARRIER CAMBER NOT TO EXCEED 1mm IN 250mm.
3. ALL DIMENSIONS MEET EIA-481-C REQUIREMENTS.
4. MATERIAL: BLACK ANTI-STATIC POLYSTYRENE.
5. THICKNESS: 0.35 ± 0.05 mm.
6. PACKING LENGTH PER 13" REEL : 24.60METERS.
7. COMPONENT LOAD PER 13" REEL : 2000PCS.
8. PEELING OFF FORCE OF TOP TAPE 0.1N~0.7N(10.2gf~100gf).

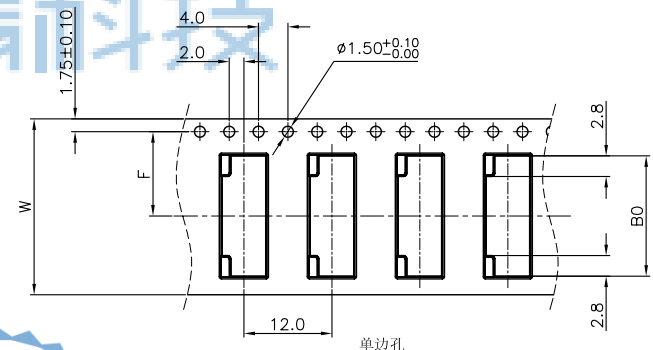
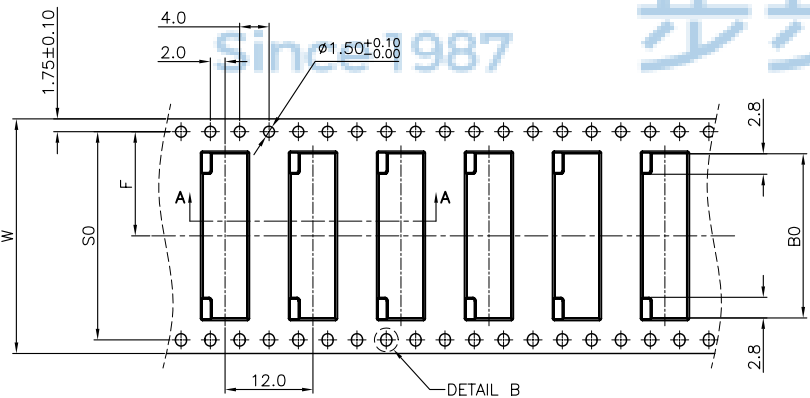
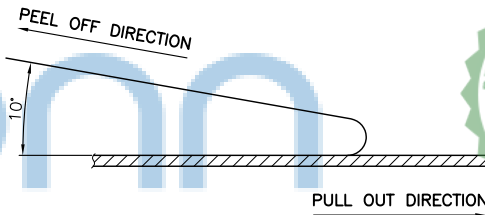
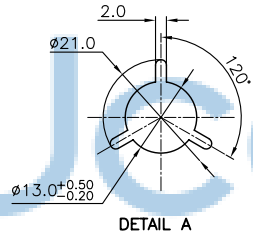
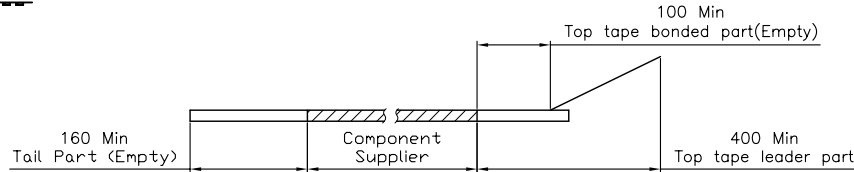
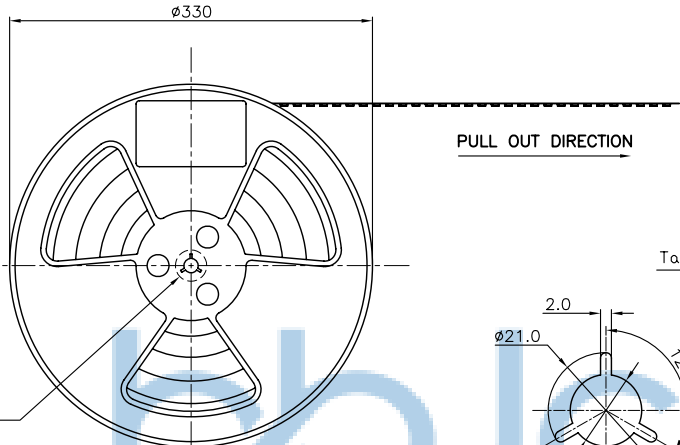
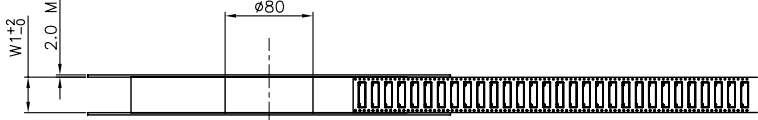

CXTS	B0±0.10	A0±0.10	W	WI	F	S0±0.10
4	7.90					
5	8.40					
6	8.90	16±0.3/-0	16.4	7.5±0.10		
7	9.40					
8	9.90					
9	10.40					
10	10.90					
11	11.40					
12	11.90					
13	12.40					
14	12.90					
15	13.40	24±0.3/-0	24.4	11.5±0.10		
16	13.90					
17	14.40					
18	14.90					
19	15.40	5.95				
20	15.90					
21	16.40					
22	16.90					
23	17.40					
24	17.90					
25	18.40					
26	18.90					
27	19.40					
28	19.90	32±0.30	32.4	14.2±0.10	28.4	
29	20.40					
30	20.90					
31	21.40					
32	21.90					
33	22.40					
34	22.90					
35	23.40					
36	23.90					
37	24.40					
38	24.90					
39	25.40					
40	25.90					
41	26.40					
42	26.90					
43	27.40					
44	27.90					
45	28.40	44±0.30	44.4	20.2±0.15	40.4	
46	28.90					
47	29.40					
48	29.90	6.50				
49	30.40					
50	30.90					
51	31.40					
52	31.90					
53	32.40					
54	32.90					
55	33.40					
56	33.90					
57	34.40					
58	34.90					
59	35.40	56±0.30	56.4	26.2±0.15	52.4	
60	35.90					

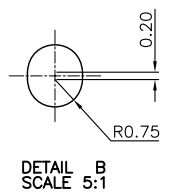
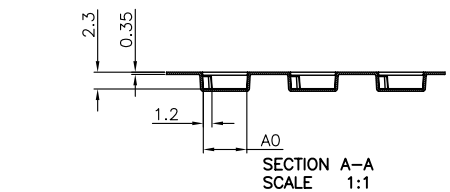

THIS DOCUMENT IS THE SOLE PROPERTY OF BBJconn Technology Co., Ltd. CORPORATION AND SHOULD NOT BE USED IN WHOLE OR IN PART WITHOUT PRIOR WRITTEN PERMISSION.

PDWG.NO: 0167-1

DR. TSP

深圳市步步精科技有限公司

NAME: FPC 0.5-22P 36A-IA½O H=2.0 (AFC07)

PJ. NO.: PC.02.02-32-2042

SIZE: A4 | DRW NO.:

FINISH: SEE NOTES | MAT'L.: SEE NOTES

SCALE: N/A | REV.: A0 | UNIT: mm | PAGE: 2/2