

REV.	ECN NO.	CONTENT	DATE	ENGINEER
AO				

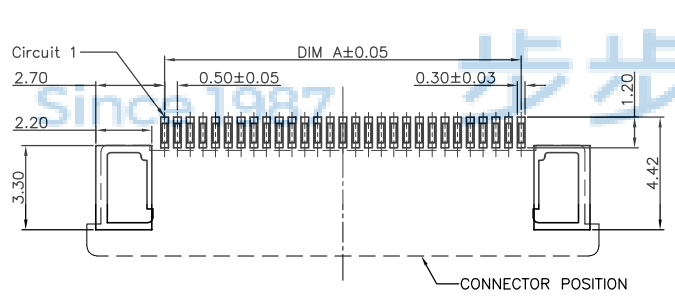

RECOMMENDED P.C.B PATTERN LAYOUT

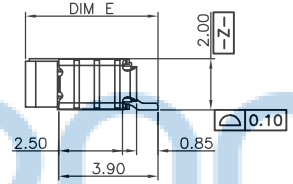
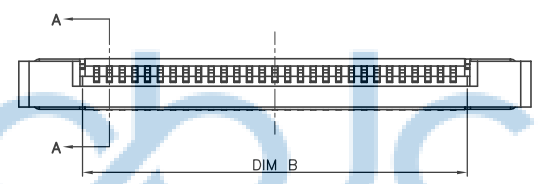
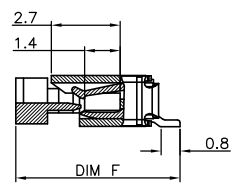
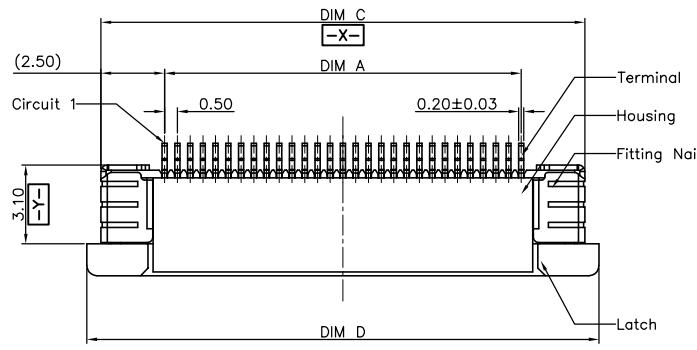
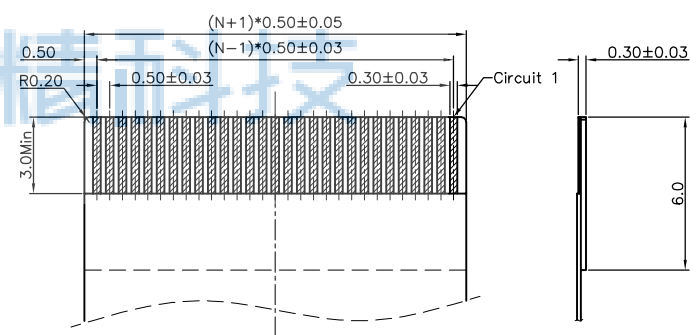

RECOMMENDED FPC/FFC DIMENSION

- Note:**
- Material:**
    - Housing: thermoplastic high temp.UL94V-0; Color: natural.
    - Latch: thermoplastic high temp.UL94V-0; Color: black.
    - Terminal: copper alloy.
    - Fitting Nail: copper alloy.
  - Finish:**
    - Terminal:**  
Underplating: Au/matt Tin overall.
    - Fitting Nail:**  
Underplating: matt Tin overall.
  - Product must comply HF RoHS specification.

CKTS	DIM A	DIM B	DIM C	DIM D	DIM E	DIM F
4	1.50	2.60	6.50	7.50		
5	2.00	3.10	7.00	8.10		
6	2.50	3.60	7.50	8.60		
7	3.00	4.10	8.00	9.10		
8	3.50	4.60	8.50	9.60		
9	4.00	5.10	9.00	10.10		
10	4.50	5.60	9.50	10.60		
11	5.00	6.10	10.00	11.10		
12	5.50	6.60	10.50	11.60		
13	6.00	7.10	11.00	12.10		
14	6.50	7.60	11.50	12.60		
15	7.00	8.10	12.00	13.10		
16	7.50	8.60	12.50	13.60		
17	8.00	9.10	13.00	14.10		
18	8.50	9.60	13.50	14.60		
19	9.00	10.10	14.00	15.10	5.20	6.45
20	9.50	10.60	14.50	15.60		
21	10.00	11.10	15.00	16.10		
22	10.50	11.60	15.50	16.60		
23	11.00	12.10	16.00	17.10		
24	11.50	12.60	16.50	17.60		
25	12.00	13.10	17.00	18.10		
26	12.50	13.60	17.50	18.60		
27	13.00	14.10	18.00	19.10		
28	13.50	14.60	18.50	19.60		
29	14.00	15.10	19.00	20.10		
30	14.50	15.60	19.50	20.60		
31	15.00	16.10	20.00	21.10		
32	15.50	16.60	20.50	21.60		
33	16.00	17.10	21.00	22.10		
34	16.50	17.60	21.50	22.60		
35	17.00	18.10	22.00	23.10		
36	17.50	18.60	22.50	23.60		
37	18.00	19.10	23.00	24.10		
38	18.50	19.60	23.50	24.60		
39	19.00	20.10	24.00	25.10		
40	19.50	20.60	24.50	25.60		
41	20.00	21.10	25.00	26.10		
42	20.50	21.60	25.50	26.60		
43	21.00	22.10	26.00	27.10		
44	21.50	22.60	26.50	27.60		
45	22.00	23.10	27.00	28.10		
46	22.50	23.60	27.50	28.60		
47	23.00	24.10	28.00	29.10		
48	23.50	24.60	28.50	29.60		
49	24.00	25.10	29.00	30.10		
50	24.50	25.60	29.50	30.60		
51	25.00	26.10	30.00	31.10		
52	25.50	26.60	30.50	31.60		
53	26.00	27.10	31.00	32.10		
54	26.50	27.60	31.50	32.60		
55	27.00	28.10	32.00	33.10		
56	27.50	28.60	32.50	33.60		
57	28.00	29.10	33.00	34.10		
58	28.50	29.60	33.50	34.60		
59	29.00	30.10	34.00	35.10		
60	29.50	30.60	34.50	35.60		



THIS DOCUMENT IS THE SOLE PROPERTY OF BBJconn Technology Co.,Ltd. Corporation AND SHOULD NOT BE USED IN WHOLE OR IN PART WITHOUT PRIOR WRITTEN PERMISSION.

PDWG.NO: 0407-1

深圳市步步精科技有限公司

NAME: FPC 0.5-8P 抽拉上接 H=2.0 编带 (AFC07系列)

APPD. JM\_Zheng

CHKD. LYX

DR. SGF

PJ. NO.: PC.02.01-32-C002

SIZE: A4 | DRW NO.:

FINISH: SEE NOTES | MAT'L.: SEE NOTES

SCALE: N/A | REV.: A0 | UNIT: mm | PAGE: 1/2

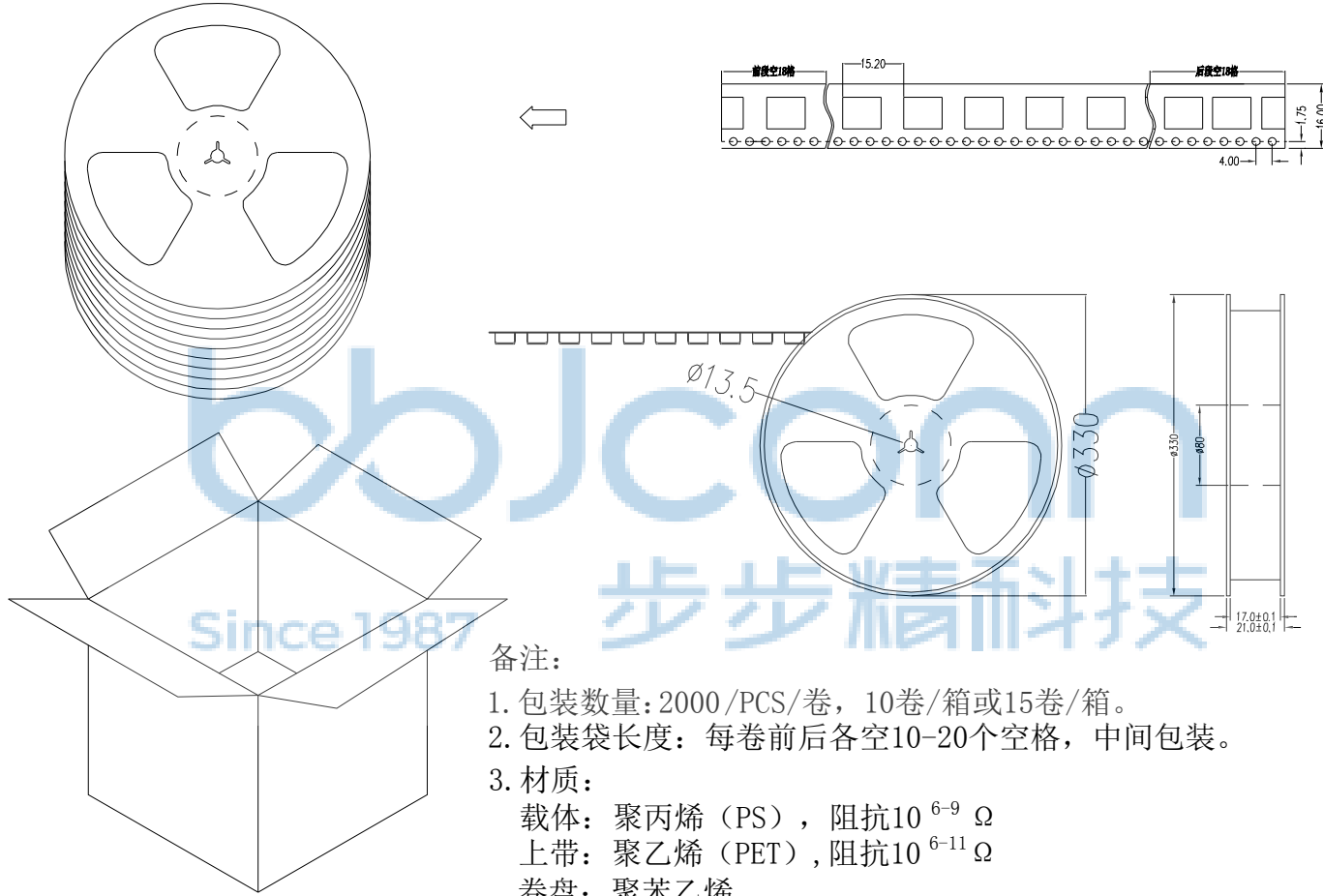

备注：  
 1. 包装数量：2000 /PCS/卷，10卷/箱或15卷/箱。  
 2. 包装袋长度：每卷前后各空10-20个空格，中间包装。  
 3. 材质：  
 载体：聚丙烯（PS），阻抗 $10^{6-9} \Omega$   
 上带：聚乙烯（PET），阻抗 $10^{6-11} \Omega$   
 卷盘：聚苯乙烯。  
 纸箱规格：345\*345\*23MM  
 纸箱规格：345\*345\*35MM

THIS DOCUMENT IS THE SOLE PROPERTY OF BBJconn Technology Co.,Ltd. Corporation AND SHOULD NOT BE USED IN WHOLE OR IN PART WITHOUT PRIOR WRITTEN PERMISSION.		深圳市步步精科技有限公司 .X: ±0.38 .X': ±3' .XX: ±0.25 .X': ±2' .XXX: ±0.13 .XX': ±1'		NAME: FPC 0.5-8P 抽拉上接 H=2.0 编带 (AFC07系列)	
APPD.	JM_Zheng	PJ. NO.: PC.02.01-32-C002 SIZE: A4 DRW NO.:		FINISH: SEE NOTES MAT'L.: SEE NOTES	
CHKD.	LYX	SCALE: N/A		REV.: A0	UNIT: mm
PDWG.NO:	0407-1	DR.	SGF		PAGE: 2/2