

REV.	ECN NO.	CONTENT	DATE	ENGINEER
A0				

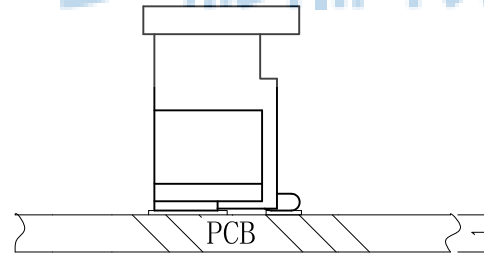
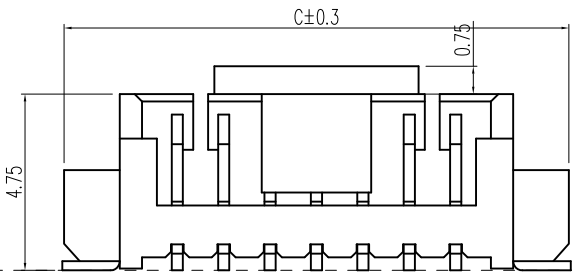
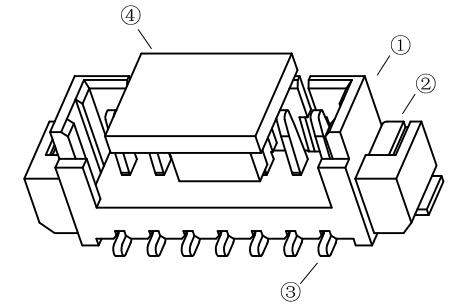
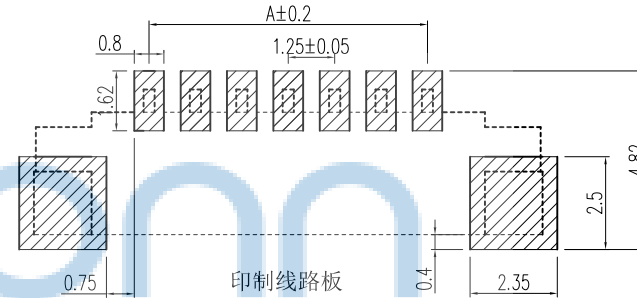
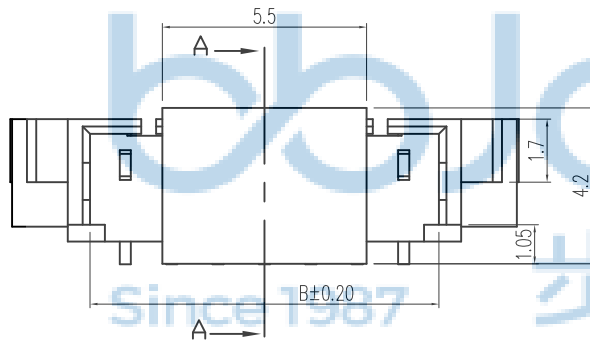
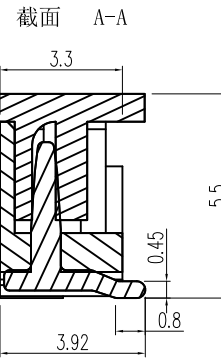
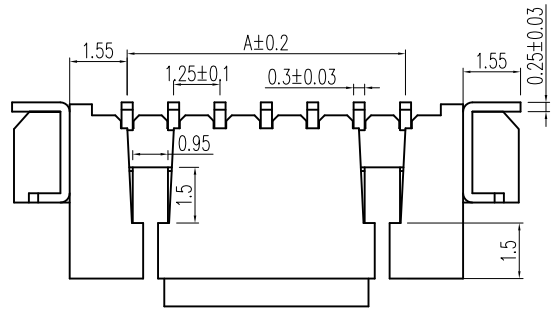

Circuits	Dimensions (mm)			Circuits	Dimensions (mm)		
	A	B	C		A	B	C
1.25LT-2P	1.25	3.10	7.30	1.25LT-12P	13.75	15.60	19.85
1.25LT-3P	2.50	4.35	8.60	1.25LT-13P	15.00	16.85	21.10
1.25LT-4P	3.75	5.60	9.80	1.25LT-14P	16.25	18.10	22.35
1.25LT-5P	5.00	6.85	11.10	1.25LT-15P	17.50	19.35	23.60
1.25LT-6P	6.25	8.10	12.30	1.25LT-16P	18.75	20.60	24.85
1.25LT-7P	7.50	9.35	13.60				
1.25LT-8P	8.75	10.60	14.90				
1.25LT-9P	10.00	11.85	16.10				
1.25LT-10P	11.25	13.10	17.30				
1.25LT-11P	12.50	14.35	18.60				

0.1 Max

NO	物料名称	规格型号	数量 (PCS)	材质	镀涂
①	基座	1.25	1	LCPE130i	本色
②	焊片	1.25	2	黄铜	锡
③	插针	1.25	2~20	黄铜	锡
④	盖板	1.25	1	LCPE130i	本色



THIS DOCUMENT IS THE SOLE PROPERTY OF BBJconn Technology Co., Ltd. CORPORATION AND SHOULD NOT BE USED IN WHOLE OR IN PART WITHOUT PRIOR WRITTEN PERMISSION.

PDWG.NO: 0050-2

DR. SGF

APPD. JM\_Zheng

CHKD. LYX

NAME: 针座 1.25-3P 立贴 加盖 米黄色

PJ. NO.: WT.04.61-85-M005

SIZE: A4 DRW NO.:

FINISH: SEE NOTES MAT'L.: SEE NOTES

SCALE: N/A REV.: A0 UNIT: mm PAGE: 1/2

深圳市步步精科技有限公司

REV.	ECN NO	CONTENT	DATE	ENGINEER
A0				

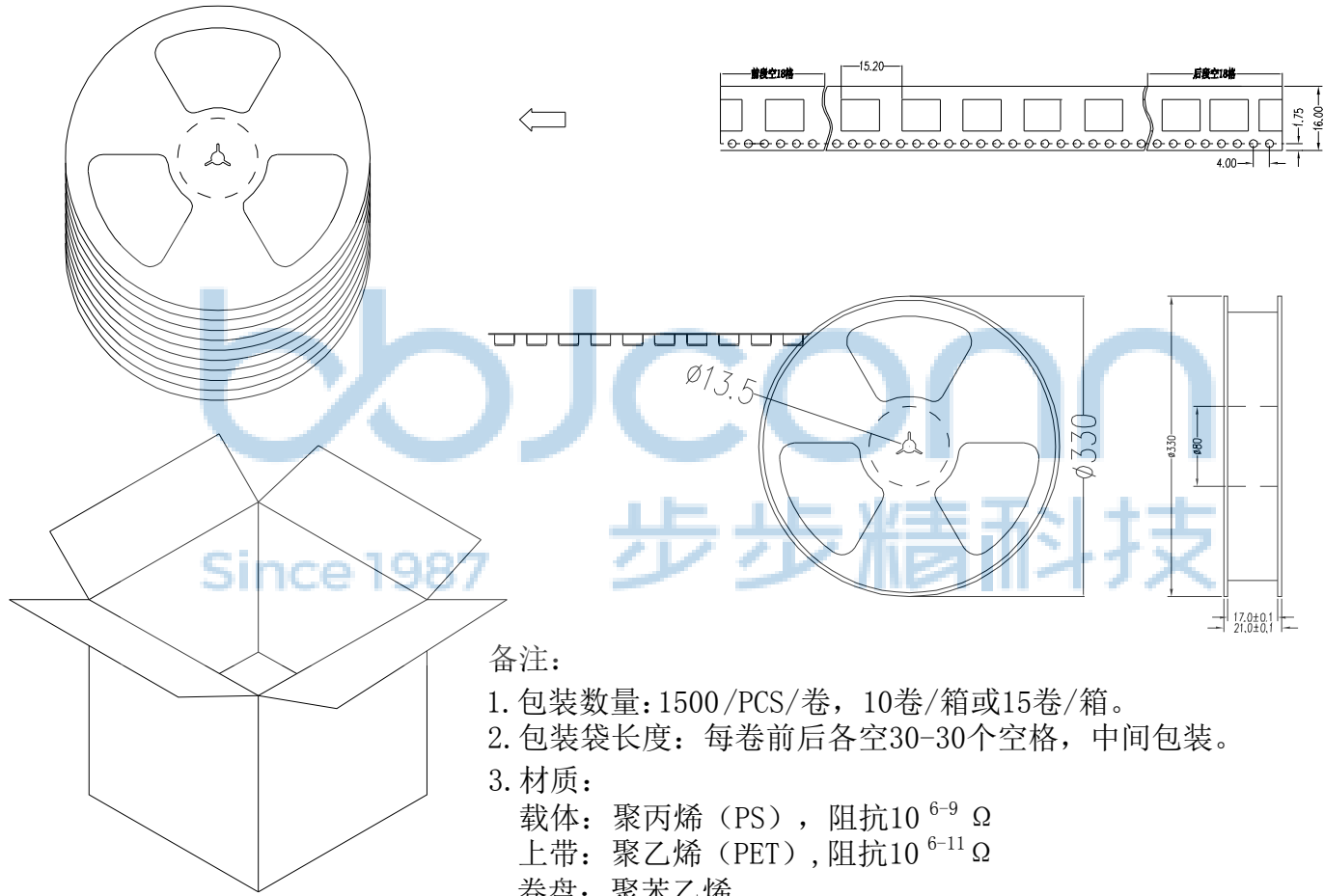

- 备注:
1. 包装数量: 1500 /PCS/卷, 10卷/箱或15卷/箱。
  2. 包装袋长度: 每卷前后各空30-30个空格, 中间包装。
  3. 材质:  
 载体: 聚丙烯 (PS), 阻抗 $10^{6-9} \Omega$   
 上带: 聚乙烯 (PET), 阻抗 $10^{6-11} \Omega$   
 卷盘: 聚苯乙烯。
- 纸箱规格: 345\*345\*23MM  
 纸箱规格: 345\*345\*35MM

THIS DOCUMENT IS THE SOLE PROPERTY OF BBJconn Technology Co.,Ltd. Corporation AND SHOULD NOT BE USED IN WHOLE OR IN PART WITHOUT PRIOR WRITTEN PERMISSION.		深圳市步步精科技有限公司	
.X: ±0.38 .XX: ±0.25 .XXX: ±0.13		X': ±3' X'': ±2' XX': ±1'	
APPD.	JM_Zheng	NAME: 针座 1.25-3P 立贴 加盖 米黄色	
CHKD.	LYX	PJ. NO.: WT.04.61-85-M005	
DR.	SGF	SIZE: A4 DRW NO.:	
PDWG.NO: 0050-2		FINISH: SEE NOTES MAT'L.: SEE NOTES	
		SCALE: N/A REV.: A0 UNIT: mm PAGE: 2/2	