

REV.	ECN NO.	CONTENT	DATE	ENGINEER
A0				

1. 技术参数:

- 1.1 额定电流: 0.5A AC/DC
- 1.2 额定电压: 50V
- 1.3 耐电压: 500V ACminute
- 1.4 接触电阻: 20mΩ MAX
- 1.5 绝缘电阻: 100MΩ MIN
- 2. 工作温度: -25℃~+85℃

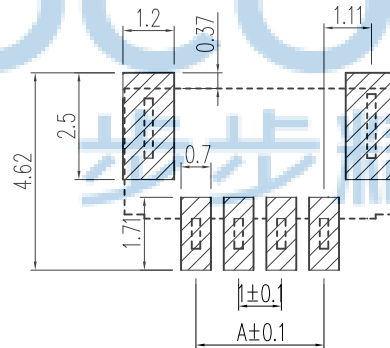
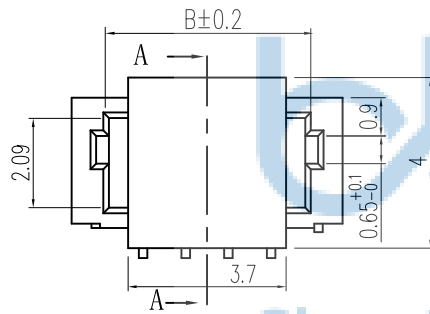
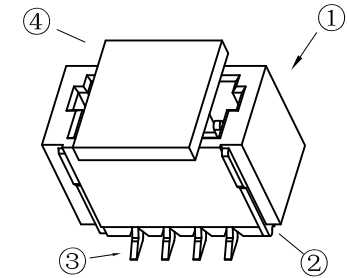
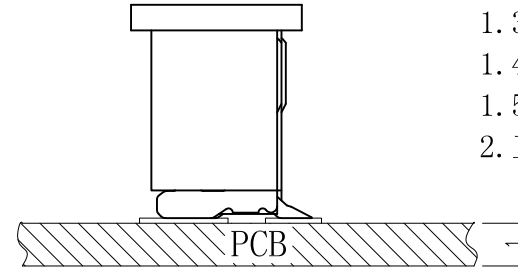
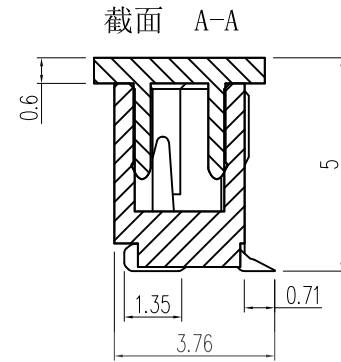
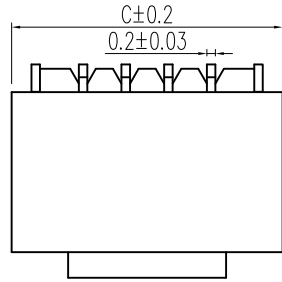

印制线路板

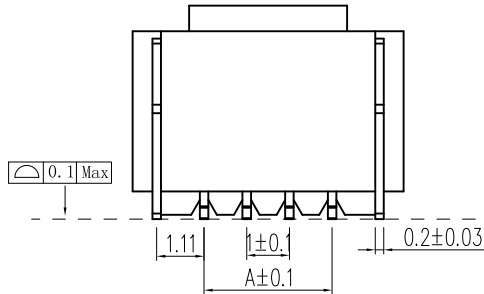

Circuits	Dimensions (mm)			Circuits	Dimensions (mm)		
	A	B	C		A	B	C
1. 0LT-2P	1.0	2.6	4.30	1. 0LT-12P	11.0	12.6	14.30
1. 0LT-3P	2.0	3.6	5.30	1. 0LT-13P	12.0	13.6	15.30
1. 0LT-4P	3.0	4.6	6.30	1. 0LT-14P	13.0	14.6	16.30
1. 0LT-5P	4.0	5.6	7.30	1. 0LT-15P	14.0	15.6	17.30
1. 0LT-6P	5.0	6.6	8.30	1. 0LT-16P	15.0	16.6	18.30
1. 0LT-7P	6.0	7.6	9.30				
1. 0LT-8P	7.0	8.6	10.30				
1. 0LT-9P	8.0	9.6	11.30				
1. 0LT-10P	9.0	10.6	12.30				
1. 0LT-11P	10.0	11.6	13.30				

NO	物料名称	规格型号	数量(PCS)	材质	镀涂
①	基座	1.0	1	LCPE130i	本色
②	焊片	1.0	2	磷铜	锡
③	插针	1.0	2~20	磷铜	锡
④	盖板	1.0	1	LCPE130i	本色



THIS DOCUMENT IS THE SOLE PROPERTY OF BBJconn Technology Co.,Ltd. Corporation AND SHOULD NOT BE USED IN WHOLE OR IN PART WITHOUT PRIOR WRITTEN PERMISSION.
PDWG.NO: 0013-1

深圳市步步精科技有限公司

NAME: 针座 1.0-2P 立贴 加盖 米黄色	PJ. NO.: WT.10.61-85-H001
APPD. JM_Zheng	SIZE: A4 DRW NO.:
CHKD. LYX	FINISH: SEE NOTES MAT'L.: SEE NOTES
DR. SGF	SCALE: N/A REV.: A0 UNIT: mm PAGE: 1/2

REV.	ECN NO	CONTENT	DATE	ENGINEER
A0				

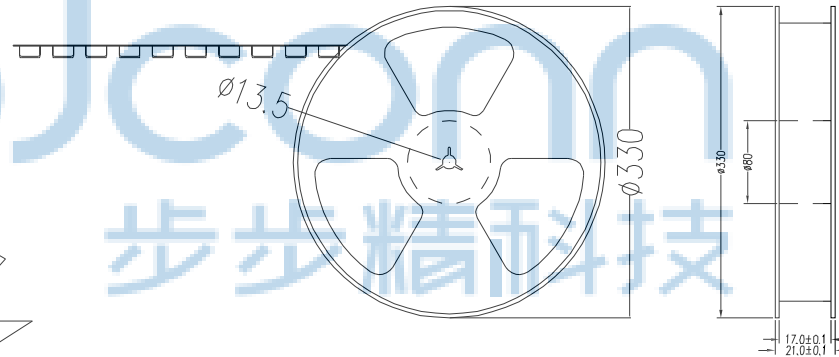
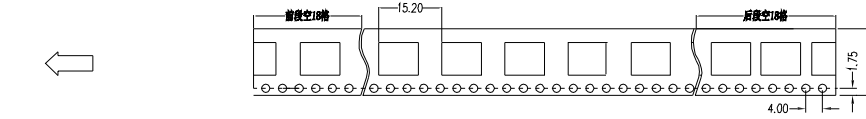
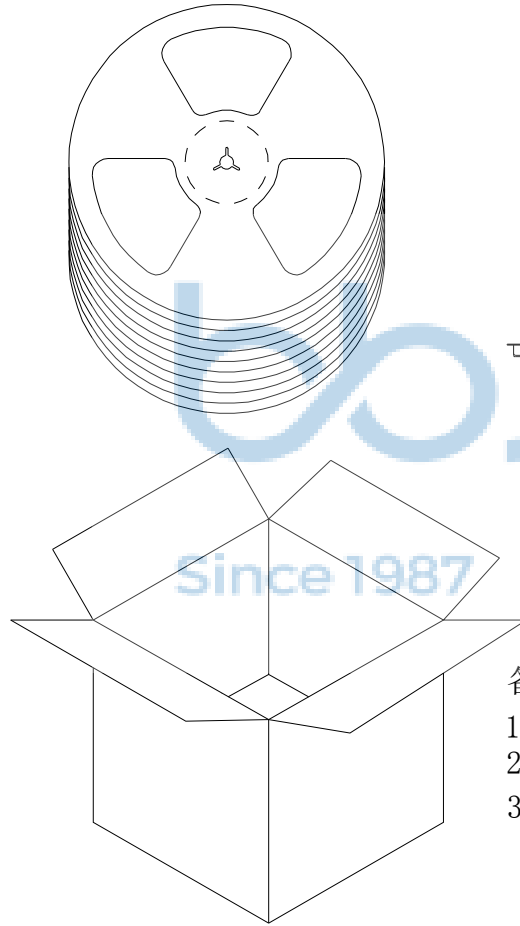

备注:

1. 包装数量: 1500/PCS/卷, 10卷/箱或15卷/箱。
2. 包装袋长度: 每卷前后各空30个空格, 中间包装。
3. 材质:
载体: 聚丙烯 (PS), 阻抗 $10^{6-9} \Omega$
上带: 聚乙烯 (PET), 阻抗 $10^{6-11} \Omega$
卷盘: 聚苯乙烯。

纸箱规格: 345*345*23MM

纸箱规格: 345*345*35MM

THIS DOCUMENT IS THE SOLE PROPERTY OF BBJconn Technology Co.,Ltd. Corporation AND SHOULD NOT BE USED IN WHOLE OR IN PART WITHOUT PRIOR WRITTEN PERMISSION.		深圳市步步精科技有限公司	
.X: ±0.38 .XX: ±0.25 .XXX: ±0.13		X': ±3" .X': ±2" .XX': ±1"	
APPD.	JM_Zheng	NAME: 针座 1.0-2P 立贴 加盖 米黄色	
CHKD.	LYX	PJ. NO.: WT.10.61-85-H001	
DR.	SGF	SIZE: A4 DRW NO.:	
PDWG.NO: 0013-1		FINISH: SEE NOTES MAT'L.: SEE NOTES	
		SCALE: N/A REV.: A0 UNIT: mm PAGE: 2/2	