

REV.	ECN NO.	CONTENT	DATE	ENGINEER
AO				

1. 技术参数:
 1.1 额定电流: 1.0A AC/DC
 1.2 额定电压: 125V
 1.3 耐电压: 500V ACminute
 1.4 接触电阻: 20mΩ MAX
 1.5 绝缘电阻: 500MΩ MIN
 2. 工作温度: -25℃~+85℃

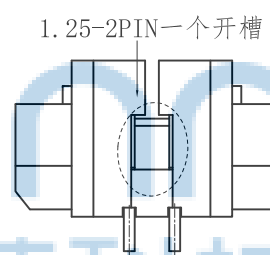

Circuits	Dimensions (mm)			
	A	B	C	D
2PIN	1.25	3.10	7.50	/
3PIN	2.50	4.35	8.80	/
4PIN	3.75	5.60	10.00	2.50
5PIN	5.00	6.85	11.30	3.75
6PIN	6.25	8.10	12.60	5.00
7PIN	7.50	9.35	13.80	6.25
8PIN	8.75	10.60	15.00	7.50
9PIN	10.00	11.85	16.30	8.75
10PIN	11.25	13.10	17.60	10.00
11IN	12.50	14.35	18.80	11.25
12PIN	13.75	15.60	20.10	12.50
13PIN	15.00	16.85	21.30	13.75
14PIN	16.25	18.10	22.55	15.00
15PIN	17.50	19.35	23.80	16.25
16PIN	18.75	20.60	25.05	17.50

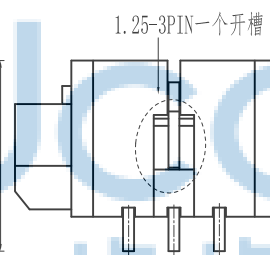
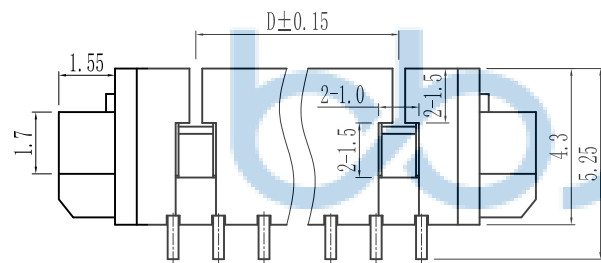
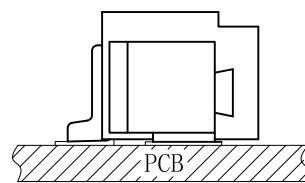
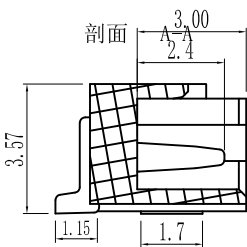
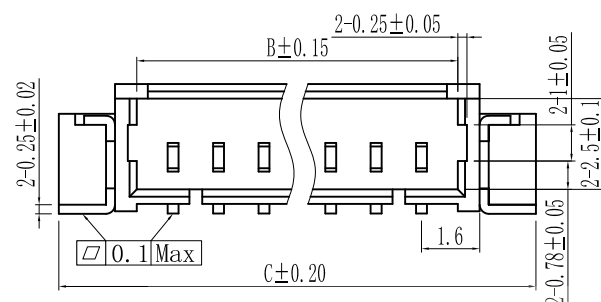
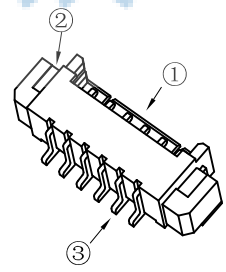
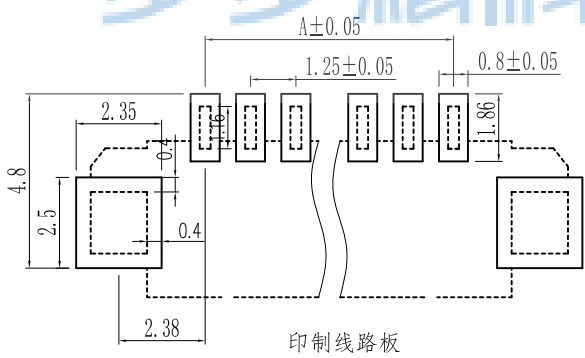
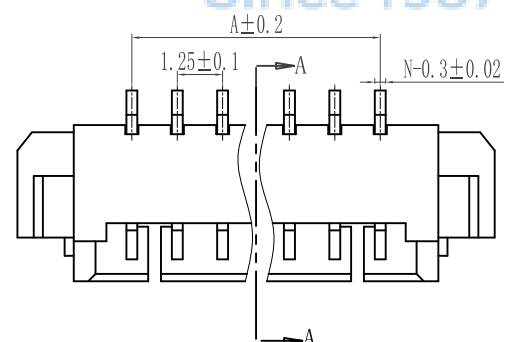

印制线路板

NO	物料名称	数量 (PCS)	材质	镀涂
①	塑胶件	1 PCS	LCP	本色
②	焊片	2 PCS	黄铜	雾锡
③	PIN针	2~16 PCS	黄铜	雾锡



THIS DOCUMENT IS THE SOLE PROPERTY OF BBJconn Technology Co., Ltd. Corporation AND SHOULD NOT BE USED IN WHOLE OR IN PART WITHOUT PRIOR WRITTEN PERMISSION.

PDWG.NO: 0013-1

DR. SGF

APPD. JM_Zheng

CHKD. LYX

NAME: 深圳市步步精科技有限公司
针座 1.25-3P 卧贴 米黄色 雾锡

PJ. NO.: WT.04.65-73-H001

SIZE: A4 DRW NO.:

FINISH: SEE NOTES MAT'L.: SEE NOTES

SCALE: N/A REV.: A0 UNIT: mm PAGE: 1/2

REV.	ECN NO.	CONTENT	DATE	ENGINEER
A0				

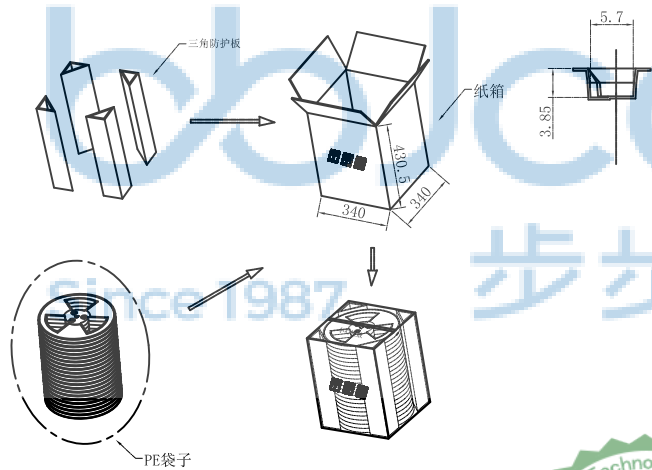
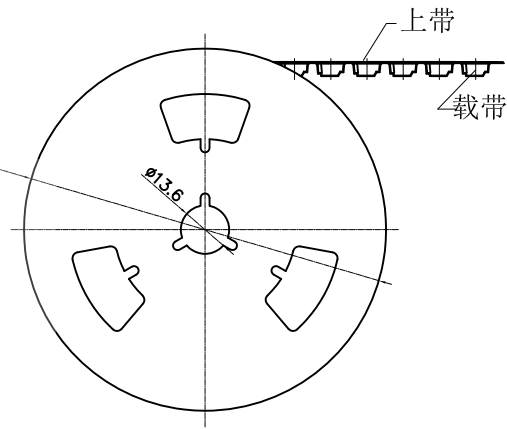
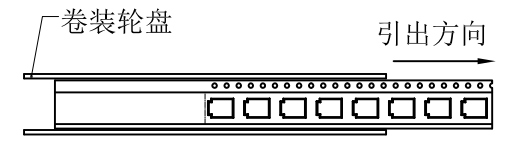
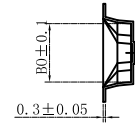
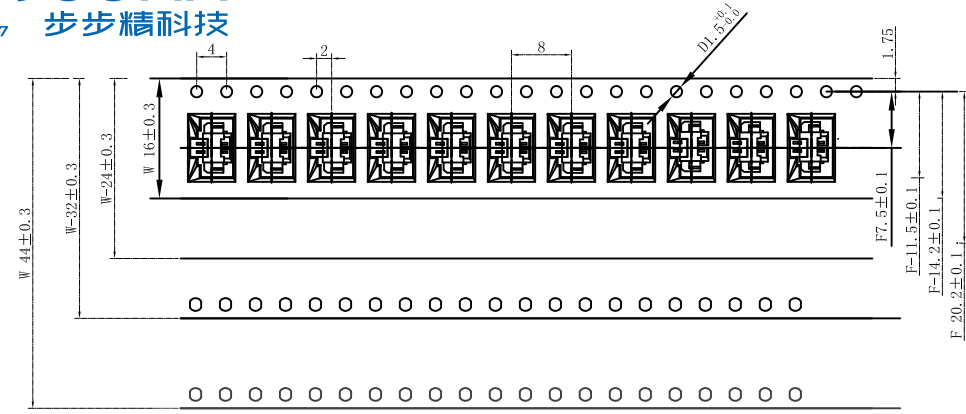

1. 上带剥离力:

2. 带子预空格:

A	15° ~ 0°
F	20° ~ 70° (g)

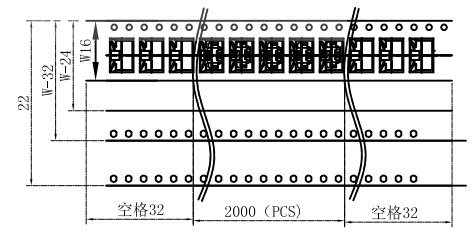

3. 载带材料规格: PS 白色料抗静电, 厚度 0.30mm.



Circuits	载带尺寸			Circuits	载带尺寸			卷装包装明细表			
	W	B0	F		W	B0	F	PIN位	每卷包装数	每件盘数	每件数量
1.25WT-2P	16.0	7.80	7.50	1.25WT-12P	32.0	20.30	14.20	02P-03P	2000 (PCS)	20 (盘)	40 (K)
1.25WT-3P	16.0	9.05	7.50	1.25WT-13P	32.0	21.55	14.20	04P-09P	2000 (PCS)	14 (盘)	28 (K)
1.25WT-4P	24.0	10.30	11.50	1.25WT-14P	44.0	22.80	20.20	10P-13P	1500 (PCS)	11 (盘)	22 (K)
1.25WT-5P	24.0	11.55	11.50	1.25WT-15P	44.0	24.05	20.20	14P-16P	1500 (PCS)	8 (盘)	16 (K)
1.25WT-6P	24.0	12.80	11.50	1.25WT-16P	44.0	25.30	20.20				
1.25WT-7P	24.0	14.05	11.50								
1.25WT-8P	24.0	15.30	11.50								
1.25WT-9P	24.0	16.55	11.50								
1.25WT-10P	32.0	17.80	14.20								
1.25WT-11P	32.0	19.05	14.20								

THIS DOCUMENT IS THE SOLE PROPERTY OF BBJconn Technology Co., Ltd. Corporation AND SHOULD NOT BE USED IN WHOLE OR IN PART WITHOUT PRIOR WRITTEN PERMISSION.

PDWG.NO: 0013-1

APPD. JM_Zheng

CHKD. LYX

DR. SGF

深圳市步步精科技有限公司

.X: ±0.38 .XX: ±0.25 .XXX: ±0.13

X': ±3" X'': ±2" XX': ±1"

NAME: 针座 1.25-3P 卧贴 米黄色 雾锡

PJ. NO.: WT.04.65-73-H001

SIZE: A4 DRW NO.:

FINISH: SEE NOTES MAT'L.: SEE NOTES

SCALE: N/A REV.: A0 UNIT: mm PAGE: 2/2