

REV.	ECN NO.	CONTENT	DATE	ENGINEER
A0				

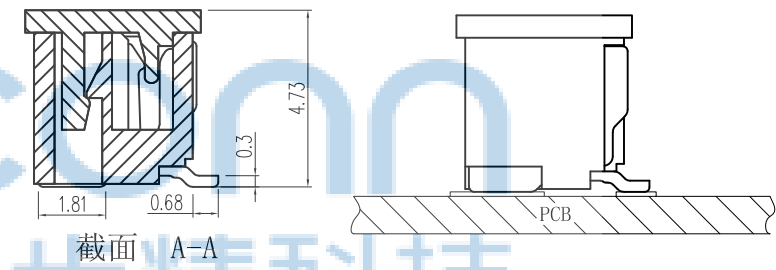

1. 技术参数:
- 1.1 额定电流: 1.0A AC/DC
 - 1.2 额定电压: 50V
 - 1.3 耐电压: 500V ACminute
 - 1.4 接触电阻: 20mΩ MAX
 - 1.5 绝缘电阻: 500MΩ MIN
2. 工作温度: -25℃~+85℃

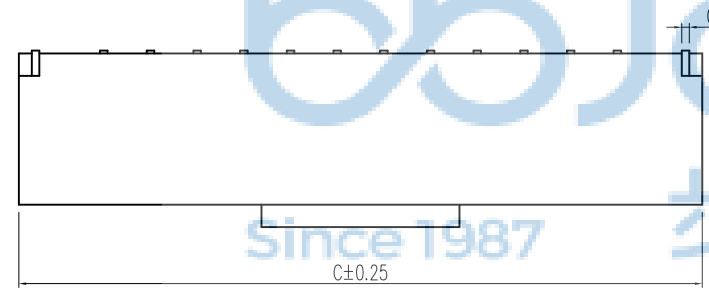
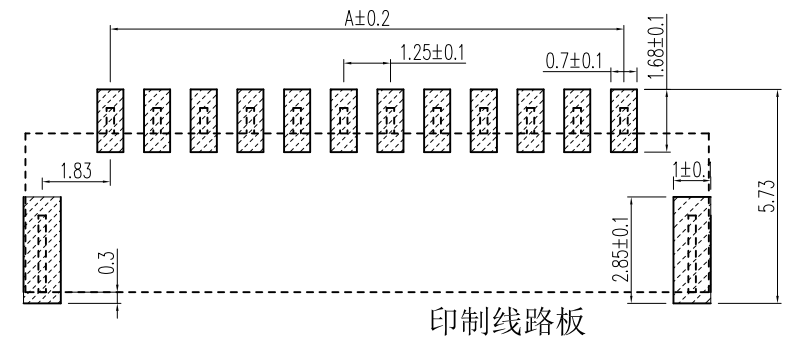
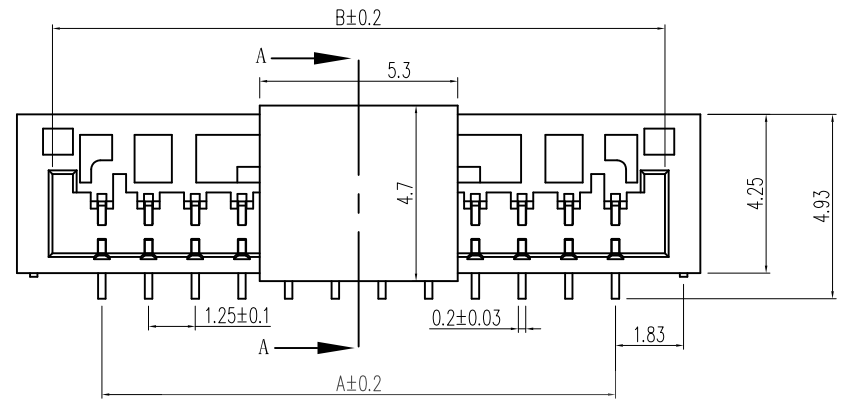
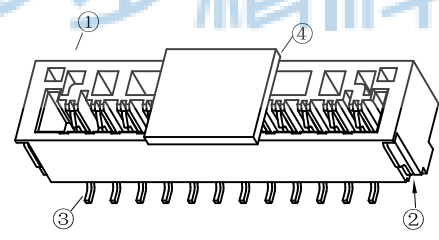

Circuits	Dimensions (mm)			Circuits	Dimensions (mm)		
	A	B	C		A	B	C
GH LT-2P	1.25	3.85	5.80	GH LT-12P	13.75	16.35	18.30
GH LT-3P	2.50	5.10	7.05	GH LT-13P	15.00	17.60	19.55
GH LT-4P	3.75	6.35	8.30	GH LT-14P	16.25	18.85	20.80
GH LT-5P	5.00	7.60	9.55	GH LT-15P	17.50	20.10	22.05
GH LT-6P	6.25	8.85	10.80	GH LT-16P	18.75	21.35	23.30
GH LT-7P	7.50	10.10	12.05				
GH LT-8P	8.75	11.35	13.30				
GH LT-9P	10.00	12.60	14.55				
GH LT-10P	11.25	13.85	15.80				
GH LT-11P	12.50	15.10	17.05				

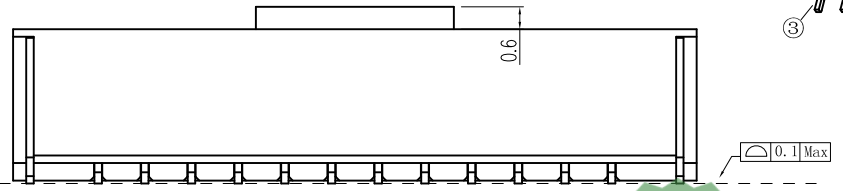

NO	物料名称	规格型号	数量(PCS)	材质	镀涂
①	基座	GH	1	LCPE130i	本色
②	焊片	GH	2	磷铜	锡
③	插针	GH	2~20	磷铜	锡
④	盖板	GH	1	LCPE130i	本色



THIS DOCUMENT IS THE SOLE PROPERTY OF BBJconn Technology Co., Ltd. Corporation AND SHOULD NOT BE USED IN WHOLE OR IN PART WITHOUT PRIOR WRITTEN PERMISSION.

PDWG.NO: 0013-1

深圳市步步精科技有限公司

NAME: 针座 1.25-11P 立贴 带扣 加盖 米黄色

PJ. NO.: WT.04.63-85-H009

SIZE: A4 DRW NO.:

FINISH: SEE NOTES MAT'L.: SEE NOTES

SCALE: N/A REV.: A0 UNIT: mm PAGE: 1/2

APPD. JM_Zheng

CHKD. LYX

DR. SGF

REV.	ECN NO	CONTENT	DATE	ENGINEER
A0				

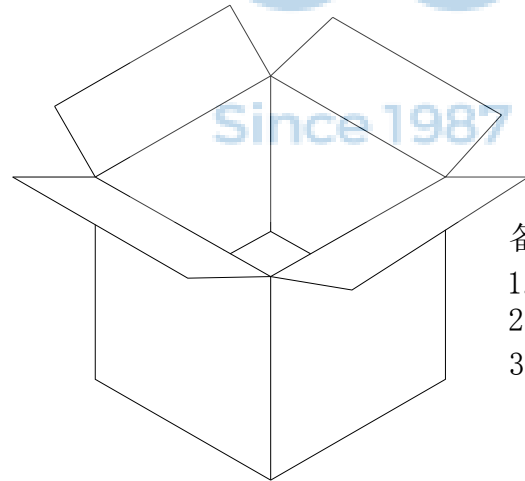
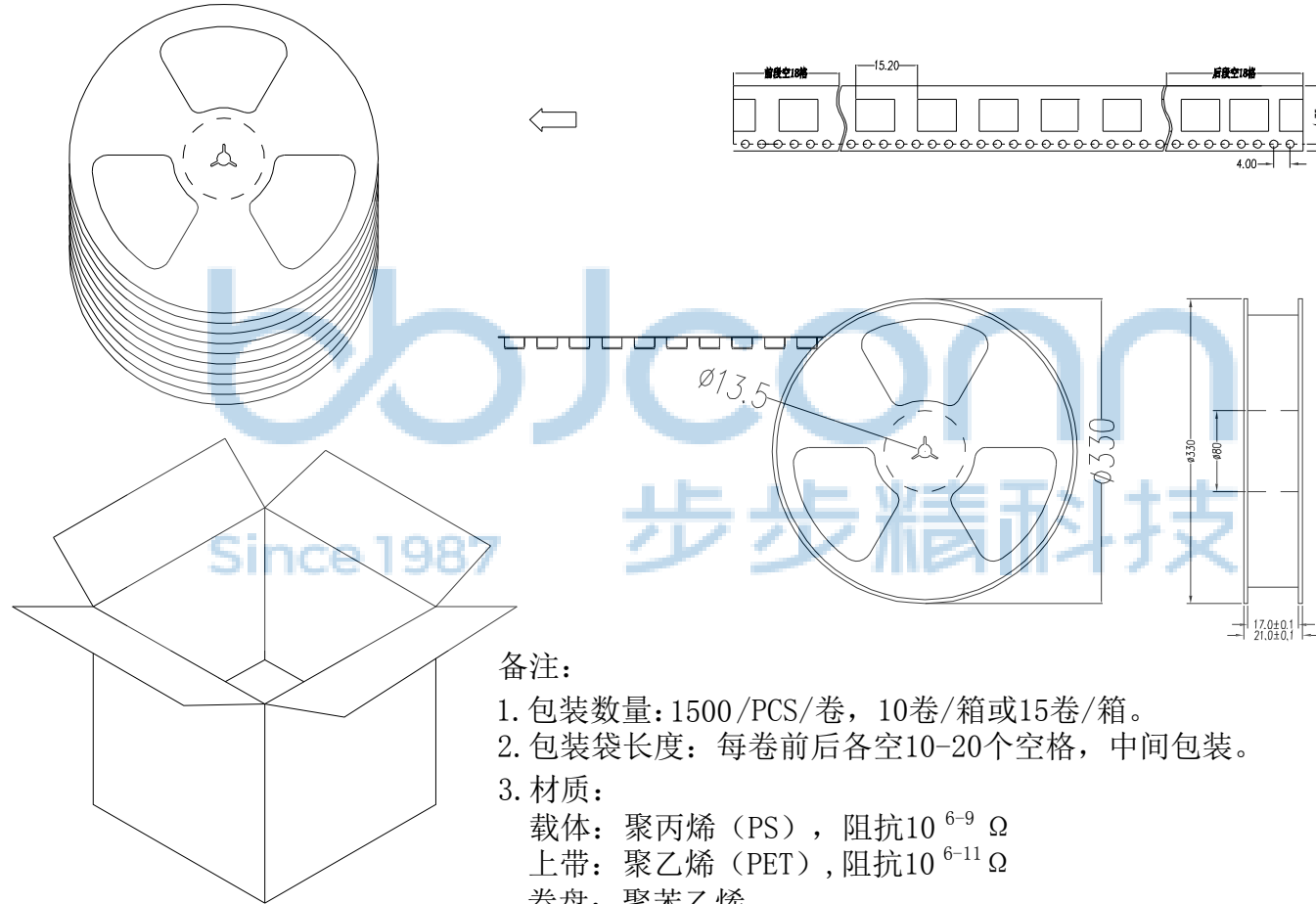

备注:

1. 包装数量: 1500/PCS/卷, 10卷/箱或15卷/箱。
2. 包装袋长度: 每卷前后各空10-20个空格, 中间包装。

3. 材质:

- 载体: 聚丙烯 (PS), 阻抗 $10^{6-9} \Omega$
- 上带: 聚乙烯 (PET), 阻抗 $10^{6-11} \Omega$
- 卷盘: 聚苯乙烯。

纸箱规格: 345*345*23MM
纸箱规格: 345*345*35MM



THIS DOCUMENT IS THE SOLE PROPERTY OF BBJconn Technology Co.,Ltd. Corporation AND SHOULD NOT BE USED IN WHOLE OR IN PART WITHOUT PRIOR WRITTEN PERMISSION.		深圳市步步精科技有限公司 .X: ±0.38 .X': ±3' .XX: ±0.25 .X': ±2' .XXX: ±0.13 .XX': ±1'		NAME: 针座 1.25-11P 立贴 带扣 加盖 米黄色	
APPD.	JM_Zheng	PJ. NO.: WT.04.63-85-H009		SIZE: A4 DRW NO.:	
CHKD.	LYX	FINISH: SEE NOTES		MAT'L.: SEE NOTES	
PDWG.NO:	0013-1	DR.	SGF	SCALE: N/A	REV.: A0
				UNIT: mm	PAGE: 2/2