

| REV. | ECN NO. | CONTENT | DATE | ENGINEER |
|------|---------|---------|------|----------|
| AO | | | | |

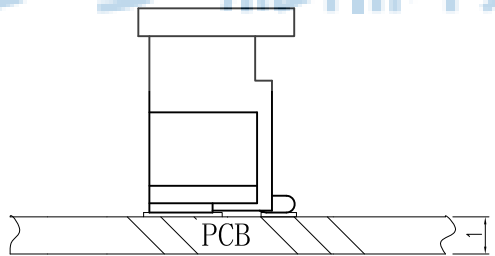

| Circuits | Dimensions (mm) | | | Circuits | Dimensions (mm) | | |
|-------------|-----------------|-------|-------|-------------|-----------------|-------|-------|
| | A | B | C | | A | B | C |
| 1. 25LT-2P | 1.25 | 3.10 | 7.30 | 1. 25LT-12P | 13.75 | 15.60 | 19.85 |
| 1. 25LT-3P | 2.50 | 4.35 | 8.60 | 1. 25LT-13P | 15.00 | 16.85 | 21.10 |
| 1. 25LT-4P | 3.75 | 5.60 | 9.80 | 1. 25LT-14P | 16.25 | 18.10 | 22.35 |
| 1. 25LT-5P | 5.00 | 6.85 | 11.10 | 1. 25LT-15P | 17.50 | 19.35 | 23.60 |
| 1. 25LT-6P | 6.25 | 8.10 | 12.30 | 1. 25LT-16P | 18.75 | 20.60 | 24.85 |
| 1. 25LT-7P | 7.50 | 9.35 | 13.60 | | | | |
| 1. 25LT-8P | 8.75 | 10.60 | 14.90 | | | | |
| 1. 25LT-9P | 10.00 | 11.85 | 16.10 | | | | |
| 1. 25LT-10P | 11.25 | 13.10 | 17.30 | | | | |
| 1. 25LT-11P | 12.50 | 14.35 | 18.60 | | | | |

| NO | 物料名称 | 规格型号 | 数量(PCS) | 材质 | 镀涂 |
|----|------|------|---------|----------|----|
| ① | 基座 | 1.25 | 1 | LCPE130i | 本色 |
| ② | 焊片 | 1.25 | 2 | 黄铜 | 锡 |
| ③ | 插针 | 1.25 | 2~20 | 黄铜 | 锡 |
| ④ | 盖板 | 1.25 | 1 | LCPE130i | 本色 |

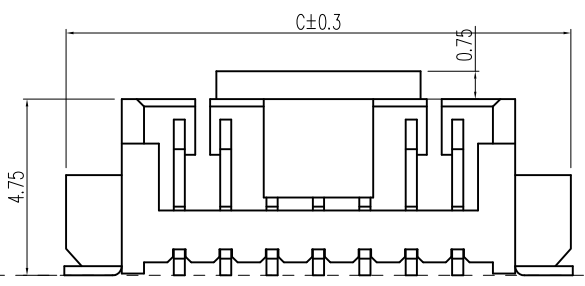
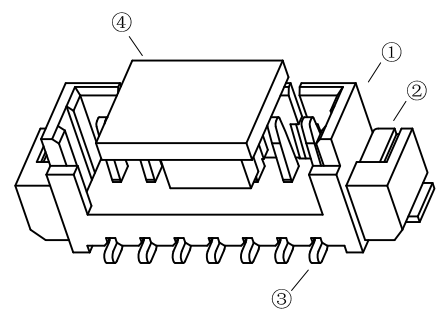
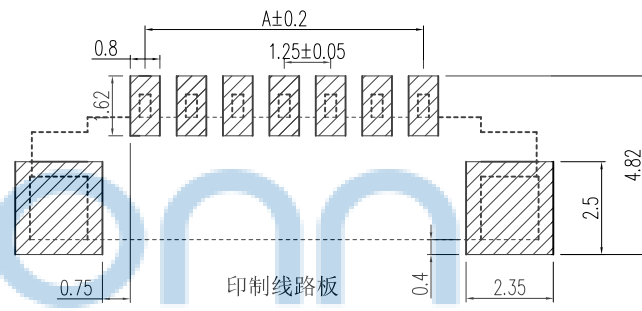
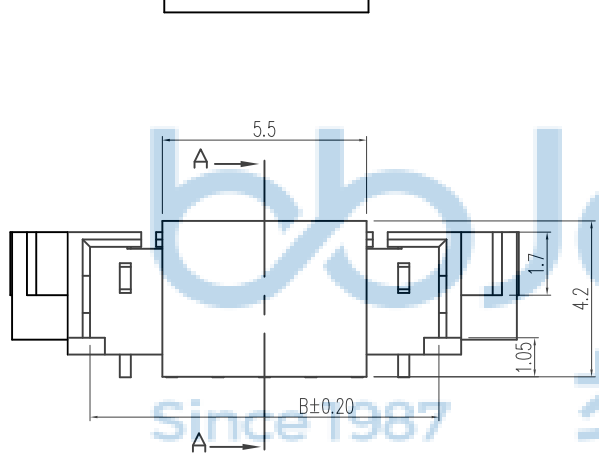
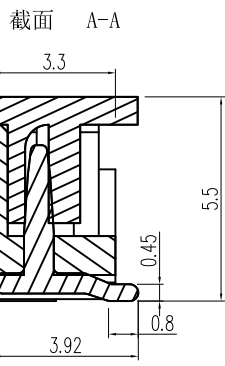
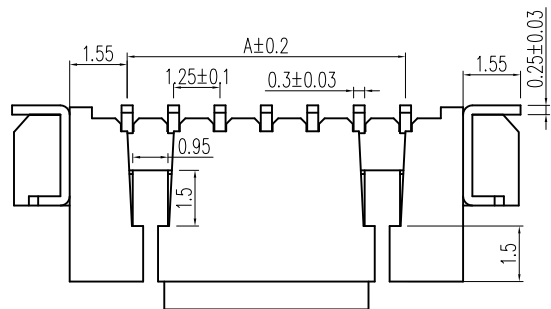

THIS DOCUMENT IS THE SOLE PROPERTY OF BBJconn Technology Co., Ltd. Corporation AND SHOULD NOT BE USED IN WHOLE OR IN PART WITHOUT PRIOR WRITTEN PERMISSION.

PDWG.NO: 0050-2

DR. SGF

APPD. JM_Zheng

CHKD. LYX

NAME: 针座 1.25-10P 立贴 加盖 米黄色

PJ. NO.: WT.04.61-85-M007

SIZE: A4 | DRW NO.:

FINISH: SEE NOTES | MAT'L.: SEE NOTES

SCALE: N/A | REV.: A0 | UNIT: mm | PAGE: 1/2

深圳市步步精科技有限公司

| REV. | ECN NO | CONTENT | DATE | ENGINEER |
|------|--------|---------|------|----------|
| A0 | | | | |

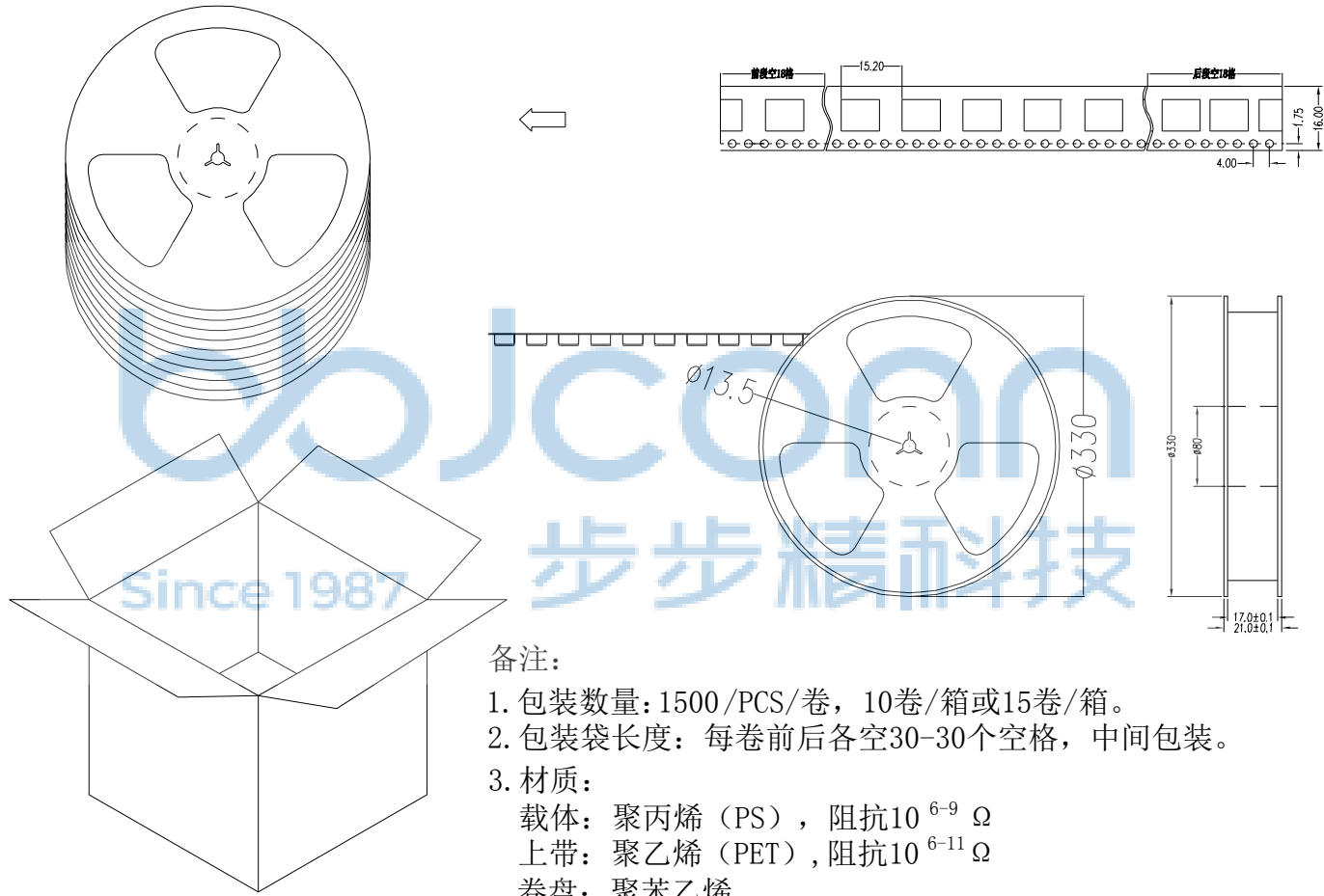

备注:

1. 包装数量: 1500 /PCS/卷, 10卷/箱或15卷/箱。
2. 包装袋长度: 每卷前后各空30-30个空格, 中间包装。
3. 材质:
载体: 聚丙烯 (PS), 阻抗 $10^{6-9} \Omega$
上带: 聚乙烯 (PET), 阻抗 $10^{6-11} \Omega$
卷盘: 聚苯乙烯。

纸箱规格: 345*345*23MM
纸箱规格: 345*345*35MM

| | | | |
|--|-----------|---|--|
| THIS DOCUMENT IS THE SOLE PROPERTY OF BBJconn Technology Co.,Ltd. Corporation AND SHOULD NOT BE USED IN WHOLE OR IN PART WITHOUT PRIOR WRITTEN PERMISSION. | |  深圳市步步精科技有限公司 | |
| .X: ±0.38 .XX: ±0.25 .XXX: ±0.13 X': ±3" X'': ±2" XX': ±1" | | NAME: 针座 1.25-10P 立贴 加盖 米黄色 | |
| APPD. JM_Zheng | CHKD. LYX | PJ. NO.: WT.04.61-85-M007 SIZE: A4 DRW NO.: | |
| PDWG.NO: 0050-2 | DR. SGF | FINISH: SEE NOTES MAT'L.: SEE NOTES SCALE: N/A REV.: A0 UNIT: mm PAGE: 2/2 | |