

REV.	ECN NO.	CONTENT	DATE	ENGINEER
A0				

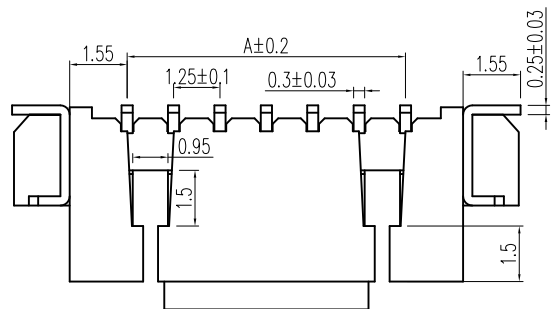

截面 A-A

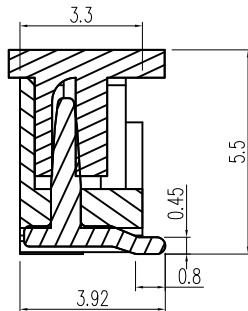

1. 技术参数:

- 1.1 额定电流: 1.0A AC/DC
- 1.2 额定电压: 125V
- 1.3 耐电压: 500V ACminute
- 1.4 接触电阻: 20mΩ MAX
- 1.5 绝缘电阻: 500MΩ MIN
- 2. 工作温度: -25℃ ~ +85℃

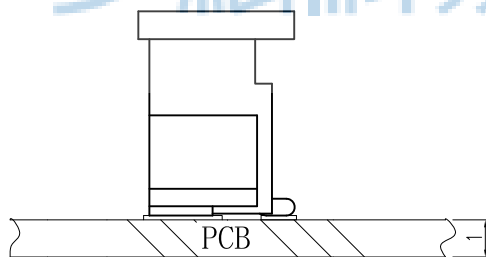
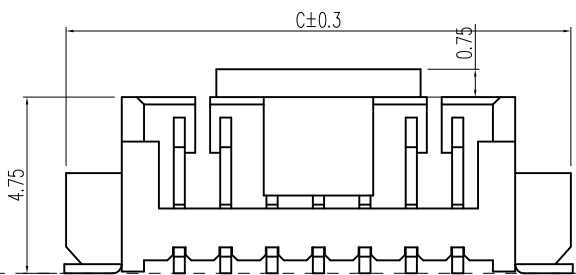
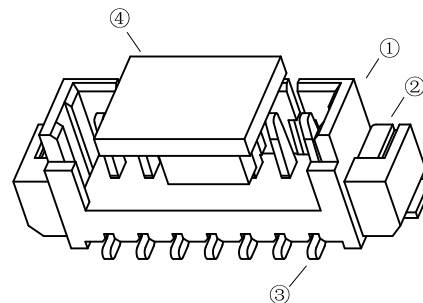
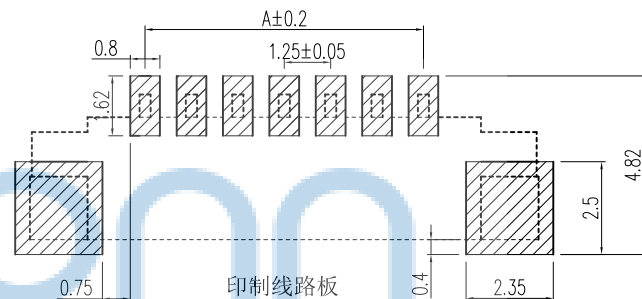
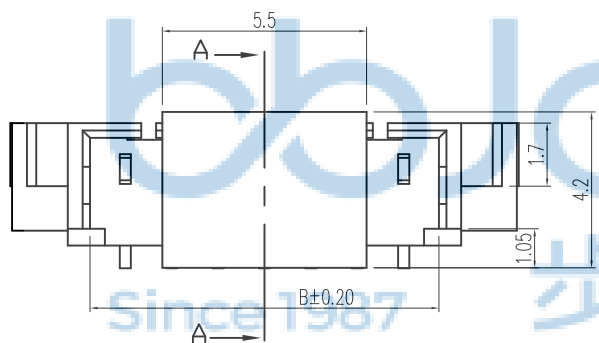

Circuits	Dimensions (mm)			Circuits	Dimensions (mm)		
	A	B	C		A	B	C
1. 25LT-2P	1.25	3.10	7.30	1. 25LT-12P	13.75	15.60	19.85
1. 25LT-3P	2.50	4.35	8.60	1. 25LT-13P	15.00	16.85	21.10
1. 25LT-4P	3.75	5.60	9.80	1. 25LT-14P	16.25	18.10	22.35
1. 25LT-5P	5.00	6.85	11.10	1. 25LT-15P	17.50	19.35	23.60
1. 25LT-6P	6.25	8.10	12.30	1. 25LT-16P	18.75	20.60	24.85
1. 25LT-7P	7.50	9.35	13.60				
1. 25LT-8P	8.75	10.60	14.90				
1. 25LT-9P	10.00	11.85	16.10				
1. 25LT-10P	11.25	13.10	17.30				
1. 25LT-11P	12.50	14.35	18.60				



THIS DOCUMENT IS THE SOLE PROPERTY OF BBJconn Technology Co., Ltd. Corporation AND SHOULD NOT BE USED IN WHOLE OR IN PART WITHOUT PRIOR WRITTEN PERMISSION.

PDWG.NO: 0013-1

DR. SGF

APPD. JM_Zheng

CHKD. LYX

NAME: 针座 1.25-8P 立贴 加盖 米黄色 雾锡

PJ. NO.: WT.04.61-85-H011

SIZE: A4 | DRW NO.:

FINISH: SEE NOTES | MAT'L.: SEE NOTES

SCALE: N/A | REV.: A0 | UNIT: mm | PAGE: 1/2

NO	物料名称	规格型号	数量(PCS)	材质	镀涂
①	基座	1.25	1	LCPE130i	本色
②	焊片	1.25	2	黄铜	锡
③	插针	1.25	2~20	黄铜	锡
④	盖板	1.25	1	LCPE130i	本色

REV.	ECN NO	CONTENT	DATE	ENGINEER
A0				

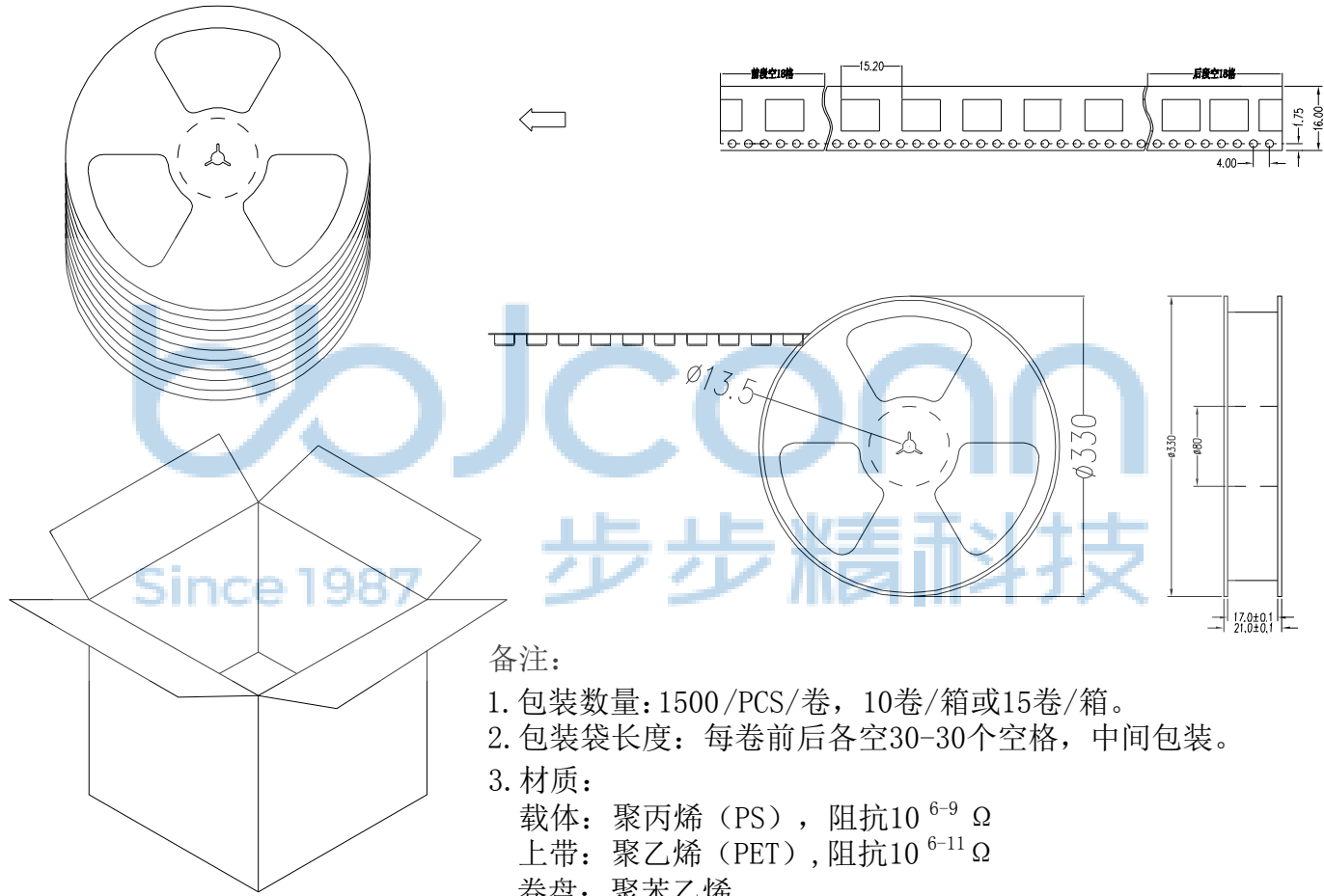

- 备注:
1. 包装数量: 1500 /PCS/卷, 10卷/箱或15卷/箱。
 2. 包装袋长度: 每卷前后各空30-30个空格, 中间包装。
 3. 材质:
 载体: 聚丙烯 (PS), 阻抗 $10^{6-9} \Omega$
 上带: 聚乙烯 (PET), 阻抗 $10^{6-11} \Omega$
 卷盘: 聚苯乙烯。
- 纸箱规格: 345*345*23MM
 纸箱规格: 345*345*35MM

THIS DOCUMENT IS THE SOLE PROPERTY OF BBJconn Technology Co.,Ltd. Corporation AND SHOULD NOT BE USED IN WHOLE OR IN PART WITHOUT PRIOR WRITTEN PERMISSION.		深圳市步步精科技有限公司 .X: ±0.38 .X': ±3" .XX: ±0.25 .X": ±2" .XXX: ±0.13 .XX': ±1"		NAME: 针座 1.25-8P 立贴 加盖 米黄色 雾锡	
APPD.	JM_Zheng	PJ. NO.: WT.04.61-85-H011 SIZE: A4 DRW NO.:		FINISH: SEE NOTES MAT'L.: SEE NOTES	
CHKD.	LYX	SCALE: N/A		REV.: A0	UNIT: mm
PDWG.NO:	0013-1	DR.	SGF	PAGE: 2/2	