

REV.	ECN NO.	CONTENT	DATE	ENGINEER
A0				

1. 技术参数:
- 1.1 额定电流: 3.0A AC/DC
 - 1.2 额定电压: 250V AC/DC
 - 1.3 耐电压: 1000V AC/minute
 - 1.4 接触电阻: 20mΩ MAX
 - 1.5 绝缘电阻: 1000MΩ MIN
2. 工作温度: -40℃ ~ +105℃

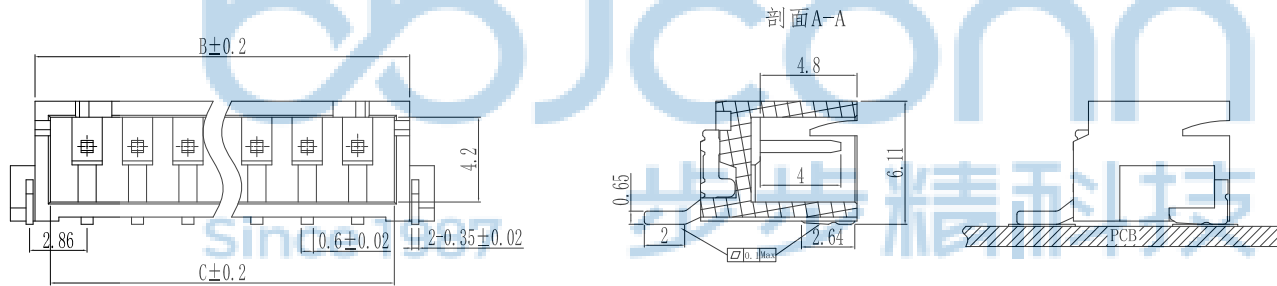

Circuits	Dimensions (mm)				
	A	B	C	D	E
2.5WT-2P	2.50	7.50	6.00	3.65	10.0
2.5WT-3P	5.00	10.0	8.50	2.50	12.5
2.5WT-4P	7.50	12.50	11.00	5.00	15.0
2.5WT-5P	10.00	15.0	13.50	7.50	17.5
2.5WT-6P	12.50	17.50	16.00	10.00	20.0
2.5WT-7P	15.00	20.0	18.50	12.50	22.5
2.5WT-8P	17.50	22.5	21.00	15.00	25.0
2.5WT-9P	20.00	25.0	23.50	17.50	27.5
2.5WT-10P	22.50	27.50	26.00	20.00	30.0
2.5WT-11P	25.00	30.0	28.50	22.50	32.5
2.5WT-12P	27.50	32.50	31.00	25.00	35.0
2.5WT-13P	30.00	35.00	33.50	27.50	37.5
2.5WT-14P	32.50	37.50	36.00	30.00	40.0
2.5WT-15P	35.00	40.00	38.50	32.50	42.5
2.5WT-16P	37.50	42.50	41.00	35.00	45.0

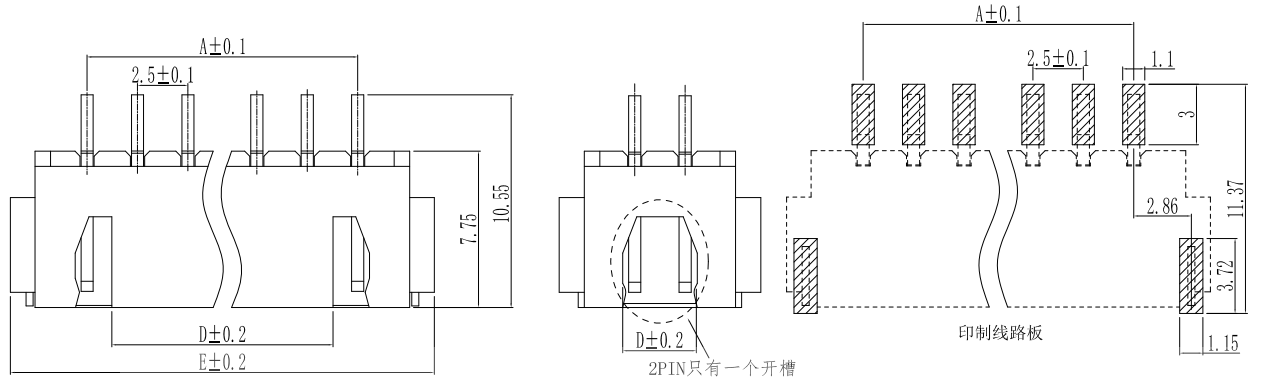
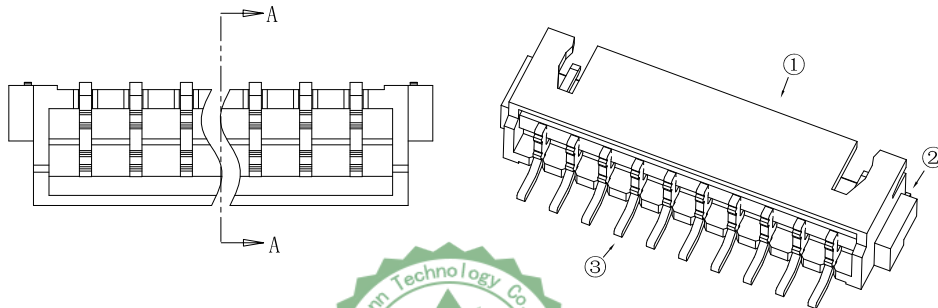

NO	物料名称	数量 (PCS)	材质	镀涂
①	塑胶件	1 PCS	LCP	本色
②	焊片	2 PCS	黄铜 H65	亮锡
③	PIN针	2~16 PCS	黄铜 H65	亮锡

THIS DOCUMENT IS THE SOLE PROPERTY OF BBJconn Technology Co., Ltd. Corporation AND SHOULD NOT BE USED IN WHOLE OR IN PART WITHOUT PRIOR WRITTEN PERMISSION.

PDWG.NO: 0013-1

DR. SGF

APPD. JM_Zheng

CHKD. LYX

深圳市步步精科技有限公司

NAME: 针座 2.54-7P 卧贴 米黄色

PJ. NO.: WT.02.61-73-H007

SIZE: A4 | DRW NO.:

FINISH: SEE NOTES | MAT'L.: SEE NOTES

SCALE: N/A | REV.: A0 | UNIT: mm | PAGE: 1/2

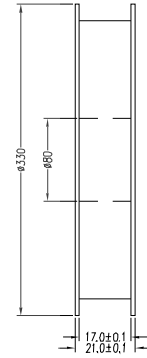
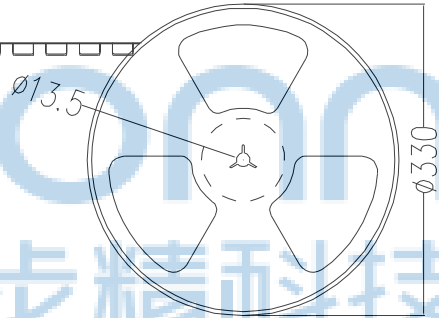
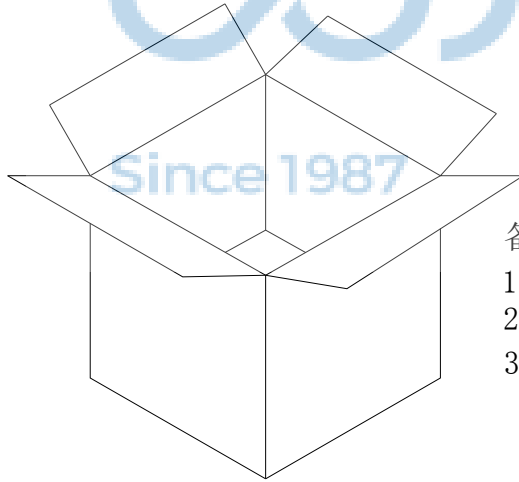
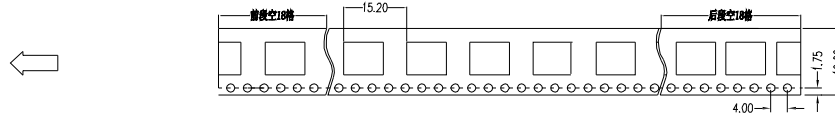
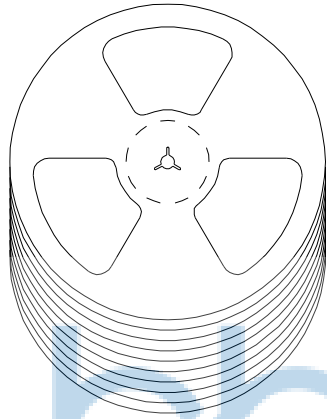

700 /PCS卷

备注:

1. 包装数量: 700/PCS/卷, 10卷/箱或15卷/箱。
2. 包装袋长度: 每卷前后各空10-20个空格, 中间包装。
3. 材质:
载体: 聚丙烯 (PS), 阻抗 $10^{6-9} \Omega$
上带: 聚乙烯 (PET), 阻抗 $10^{6-11} \Omega$
卷盘: 聚苯乙烯。

纸箱规格: 345*345*23MM

纸箱规格: 345*345*35MM

THIS DOCUMENT IS THE SOLE PROPERTY OF BBJconn Technology Co.,Ltd. Corporation AND SHOULD NOT BE USED IN WHOLE OR IN PART WITHOUT PRIOR WRITTEN PERMISSION.		深圳市步步精科技有限公司	
.X: ±0.38 .XX: ±0.25 .XXX: ±0.13		X': ±3" .X': ±2" .XX': ±1"	
APPD.	JM_Zheng	NAME: 针座 2.54-7P 卧贴 米黄色	
CHKD.	LYX	PJ. NO.: WT.02.61-73-H007	
PDWG.NO:	0013-1	SIZE: A4 DRW NO.:	
DR.	SGF	FINISH: SEE NOTES MAT'L.: SEE NOTES	
		SCALE: N/A	REV.: A0
		UNIT: mm	PAGE: 2/2