

REV.	ECN NO	CONTENT	DATE	ENGINEER
A0				

使用温度范围 (Ambient temperature Range): $-25^{\circ} \sim +85^{\circ}$
 适用基板厚度 (Applicable PCboard thickness): 0.8mm~1.6mm
 额定电压 (Voltage rating): 50V AC, DC
 额定电流 (Current rating): 1A
 接触电阻 (Contact Resistance): $\leq 0.01 \Omega$
 绝缘电阻 (Insulation Resistance): $\geq 500M \Omega$
 耐压 (Withstand Voltage): 500V/min
 材料 (Material)
 1. 基座: LCP 94V-0 or u1
 2. 插针: 黄铜

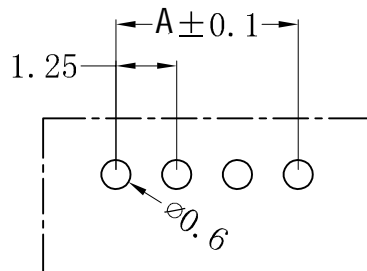

1.25弯针	A-mm	B-mm
1.25-2P	1.25mm	4.50mm
1.25-3P	2.50mm	5.75mm
1.25-4P	3.75mm	7.00mm
1.25-5P	5.00mm	8.25mm
1.25-6P	6.25mm	9.50mm
1.25-7P	7.50mm	10.75mm
1.25-8P	8.75mm	12.00mm
1.25-9P	10.00mm	13.25mm
1.25-10P	11.25mm	14.50mm
1.25-11P	12.50mm	15.75mm
1.25-12P	13.75mm	17.00mm
1.25-13P	15.00mm	18.25mm
1.25-14P	16.25mm	19.50mm
1.25-15P	17.50mm	20.75mm
1.25-16P	18.75mm	22.00mm

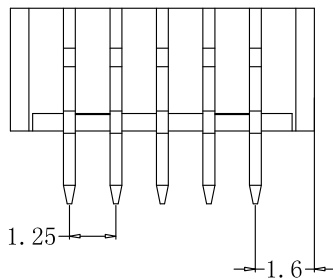
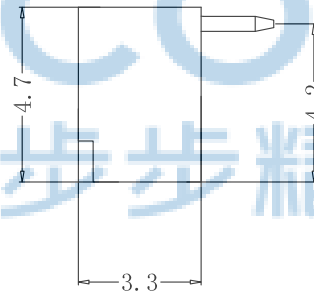
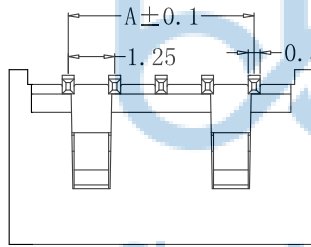
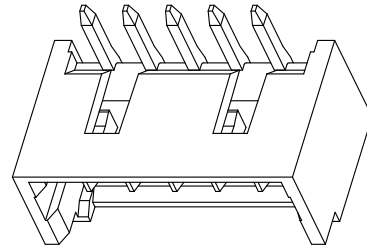
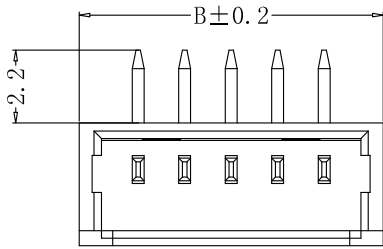

THIS DOCUMENT IS THE SOLE PROPERTY OF BBJconn Technology Co., Ltd. Corporation AND SHOULD NOT BE USED IN WHOLE OR IN PART WITHOUT PRIOR WRITTEN PERMISSION.		深圳市步步精科技有限公司 NAME: 1.25-2AW 闭口弯针 米黄色	
APPD.	JM_Zheng	PJ. NO.: WT.04.65-21-1008 SIZE: A4 DRW NO.:	FINISH: SEE NOTES MAT'L.: SEE NOTES SCALE: N/A REV.: A0 UNIT: mm PAGE: 1/2
CHKD.	LYX		
PDWG.NO:	0102-1	DR.	SGF

REV.	ECN NO	CONTENT	DATE	ENGINEER
A0				

PE袋规格:***X*** (以实际出货为准)

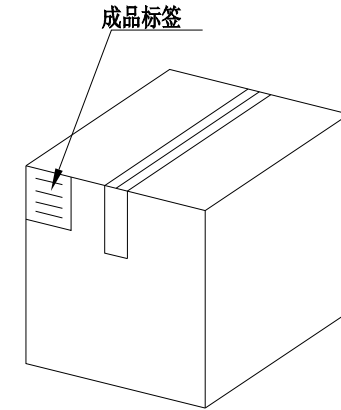
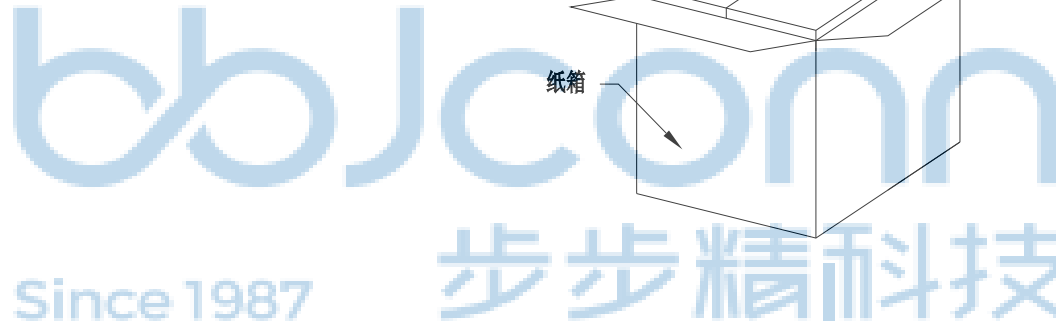
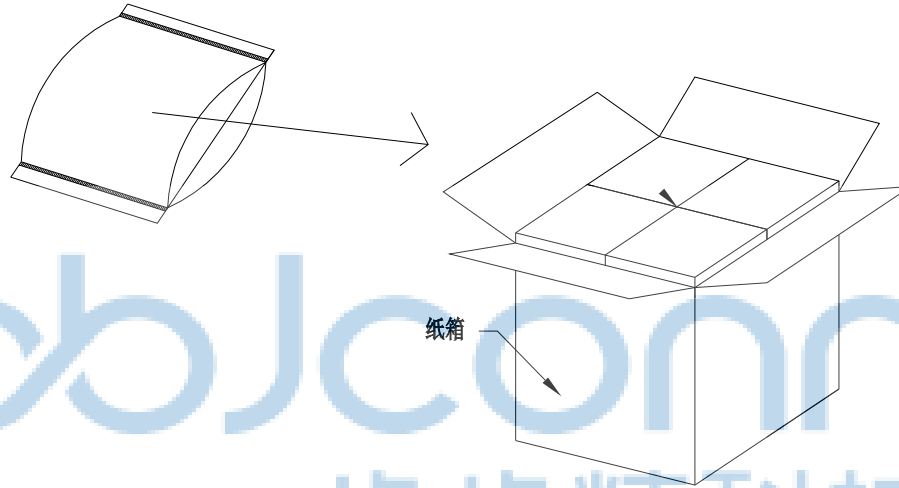

1. 包装要求:

- 1.1 每PE袋包装 2000PCS;
- 1.2 每1袋放一小纸盒;
- 1.3 每20个小纸盒放一个纸箱, 共计40000PCS
- 1.4 纸箱外贴上标签



THIS DOCUMENT IS THE SOLE PROPERTY OF BBJconn Technology Co.,Ltd. Corporation AND SHOULD NOT BE USED IN WHOLE OR IN PART WITHOUT PRIOR WRITTEN PERMISSION.		深圳市步步精科技有限公司 .X: ±0.38 X': ±3' .XX: ±0.25 .X": ±2" .XXX: ±0.13 .XX': ±1"		NAME: 1.25-2AW 闭口弯针 米黄色 PJ. NO.: WT.04.65-21-1008 SIZE: A4 DRW NO.: FINISH: SEE NOTES MAT'L.: SEE NOTES SCALE: N/A REV.: A0 UNIT: mm PAGE: 2/2	
APPD.	JM_Zheng	CHKD.	LYX	DR.	SGF
PDWG.NO: 0102-1					