

REV.	ECN NO.	CONTENT	DATE	ENGINEER
AO			2023 20/04	

- CONTACT CURRENT RATING: 1A.
- CONTACT RESISTANCE: 50 mΩ MAX.;
- INSULATION RESISTANCE: 100MΩ MIN.;
- DIELECTRIC WITHSTANDING: 500V AC MIN.;
- DURABILITY: 5,000 CYCLES MIN.;
- CONNECTOR MATING FORCES: 30N MAX.;
- CONNECTOR UNMATING FORCES: 3N MIN.;

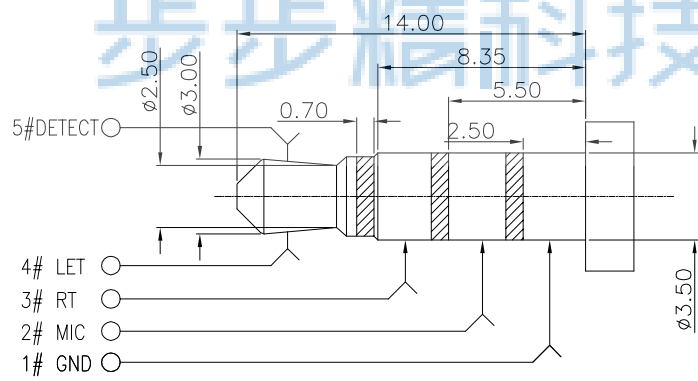

P.C.B LAYOUT  
TOP VIEW

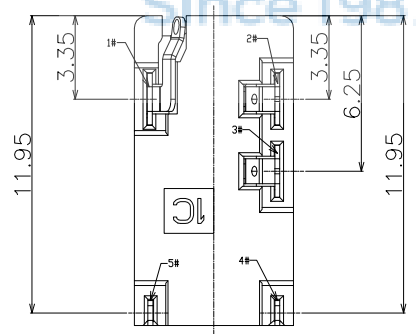
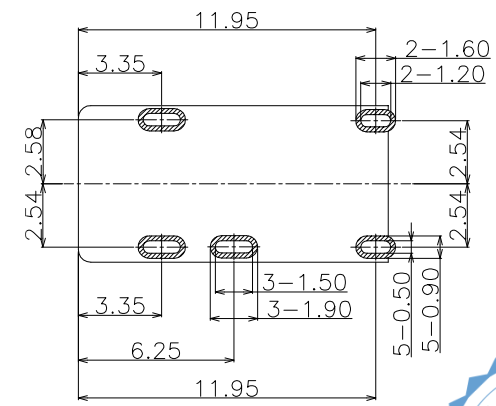
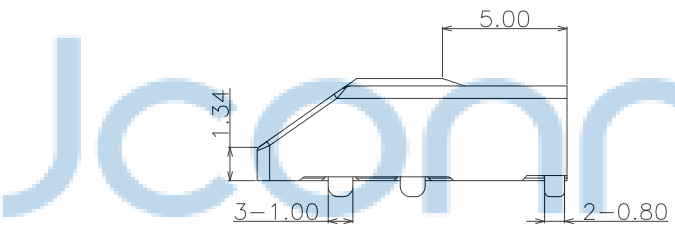
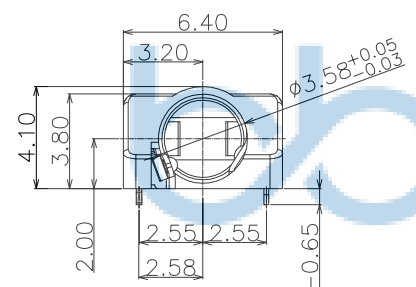
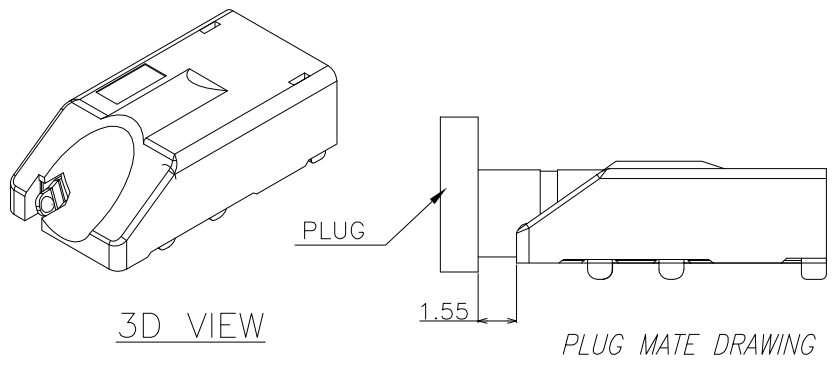
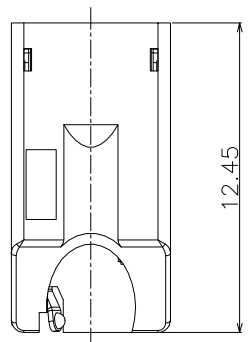
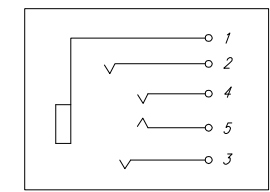

5	DETECT
4	LET
3	RT
2	MIC
1	GND

SCHEMATIC

( $\phi 3.50$ mm 4 POLE PLUG DETAIL DRAWING)

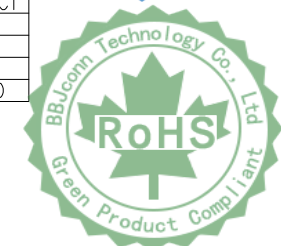

ITEM	NAME	Q'TY	DESCRIPTION	NOTE
6	TERMINAL 5#	1	STAINLESS STEEL; NICKEL UNDER PLATING OVERALL, GOLD PLATING ON SOLDER AREA; GOLD PLATING ON CONTACT AREA	
5	TERMINAL 4#	1	STAINLESS STEEL; NICKEL UNDER PLATING OVERALL, GOLD PLATING ON SOLDER AREA; GOLD PLATING ON CONTACT AREA	
4	TERMINAL 3#	1	PHOSPHOR BRONZE; NICKEL UNDER PLATING OVERALL, GOLD PLATING ON SOLDER AREA; GOLD PLATING ON CONTACT AREA	
3	TERMINAL 2#	1	PHOSPHOR BRONZE; NICKEL UNDER PLATING OVERALL, GOLD PLATING ON SOLDER AREA; GOLD PLATING ON CONTACT AREA	
2	TERMINAL 1#	1	PHOSPHOR BRONZE; NICKEL UNDER PLATING OVERALL, GOLD PLATING ON SOLDER AREA; GOLD PLATING ON CONTACT AREA	
1	HOUSING	1	HIGHT TEMPERATURE PLASTIC; COLOR BLACK	

THIS DOCUMENT IS THE SOLE PROPERTY OF BBJconn Technology Co.,Ltd. Corporation AND SHOULD NOT BE USED IN WHOLE OR IN PART WITHOUT PRIOR WRITTEN PERMISSION.

PDWG.NO: 0076-1

DR. SGF 23/05'02

APPD. JM\_Zheng 23/05'02

CHKD. LYX 23/05'02

NAME: 3.5耳机座 斜口 五脚插 四节 (PJ35A016-F05G1ER-A)

PJ. NO.: PJ.02.22-01-3003

SIZE: A4 DRW NO.:

FINISH: SEE NOTES MAT'L.: SEE NOTES

SCALE: N/A REV.: A0 UNIT: mm PAGE: 1/1

深圳市步步精科技有限公司

REV.	ECN NO.	CONTENT	DATE	ENGINEER
A0			2023 20/04	

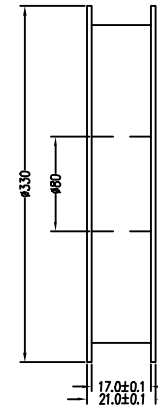
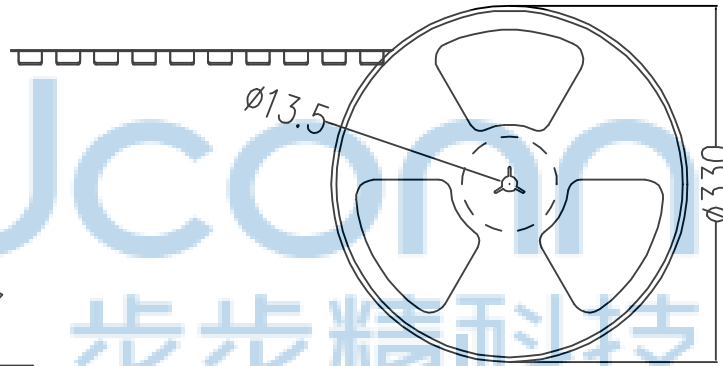
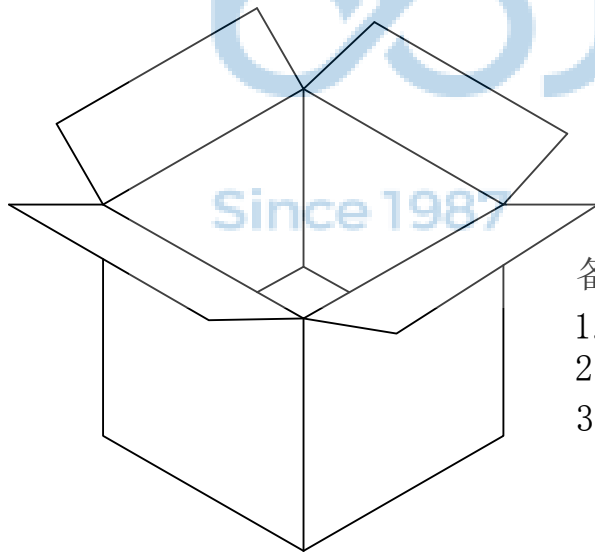
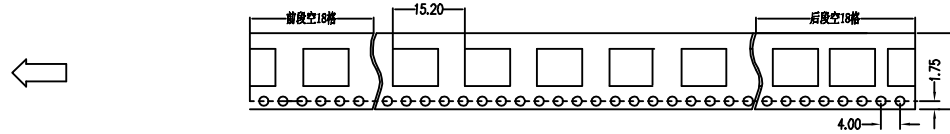
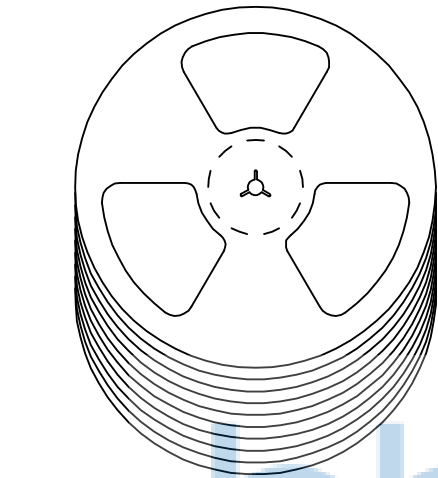

备注:

1. 包装数量: 1000/PCS/卷, 10卷/箱或15卷/箱。
2. 包装袋长度: 每卷前后各空10-20个空格, 中间包装。
3. 材质:  
载体: 聚丙烯 (PS), 阻抗 $10^{6-9} \Omega$   
上带: 聚乙烯 (PET), 阻抗 $10^{6-11} \Omega$   
卷盘: 聚苯乙烯。

纸箱规格: 345\*345\*23MM

纸箱规格: 345\*345\*35MM

THIS DOCUMENT IS THE SOLE PROPERTY OF BBJconn Technology Co.,Ltd. Corporation AND SHOULD NOT BE USED IN WHOLE OR IN PART WITHOUT PRIOR WRITTEN PERMISSION.		深圳市步步精科技有限公司 .X: ±0.38    .X': ±3" .XX: ±0.25    .X": ±2" .XXX: ±0.13    .XX': ±1"		NAME: 3.5耳机座 斜口 五脚插 四节 (PJ35A016-F05G1ER-A)				
APPD.	JM_Zheng	23/05'02	PJ. NO.: PJ.02.22-01-3003		SIZE: A4	DRW NO.:		
CHKD.	LYX	23/05'02	FINISH: SEE NOTES		MAT'L.: SEE NOTES			
PDWG.NO:	0076-1	DR.	SGF	23/05'02	SCALE: N/A	REV.: A0	UNIT: mm	PAGE: 1/1