

REV.	ECN NO.	CONTENT	DATE	ENGINEER
A0			2023 20/04	

- CONTACT CURRENT RATING: 1A.
- CONTACT RESISTANCE: 100 mΩ MAX.;
- INSULATION RESISTANCE: 100MΩ MIN.;
- DIELECTRIC WITHSTANDING: 500V AC MIN.;
- DURABILITY: 5,000 CYCLES MIN.;
- CONNECTOR MATING FORCES: 29.4N (3.00Kgf) MAX.;
- CONNECTOR UNMATING FORCES: 2.94N(0.30Kgf) MIN.;

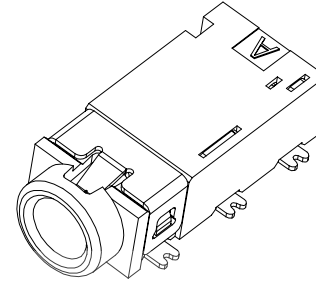

3D VIEW

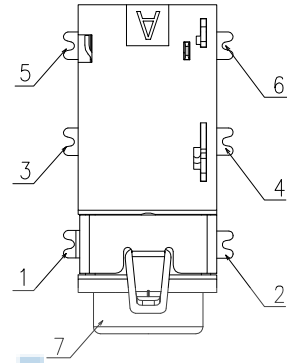
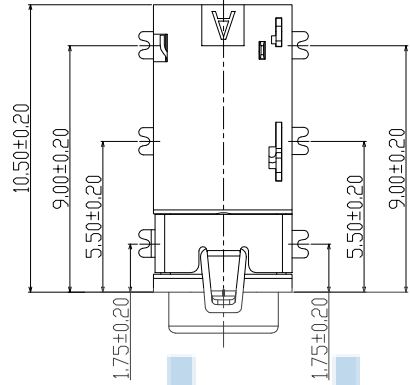
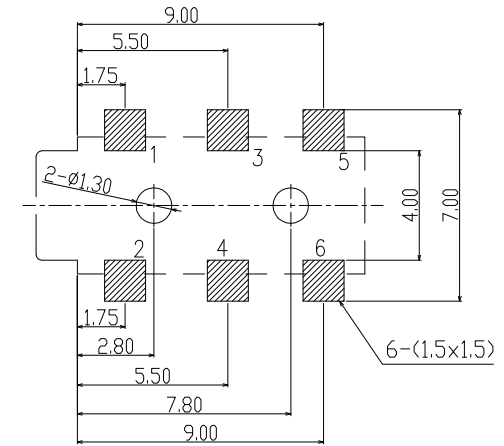

P.C.B. LAYOUT
TOP VIEW

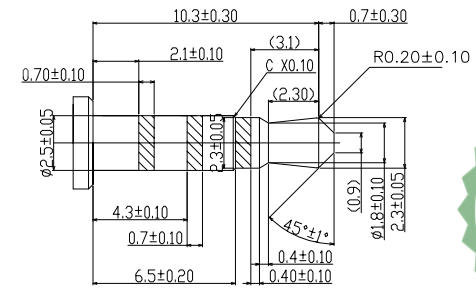
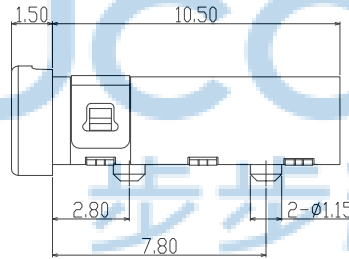
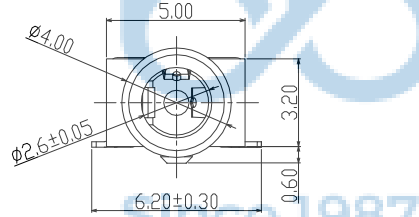

(Ø2.50mm 4 POLE PLUG DETAIL DRAWING)

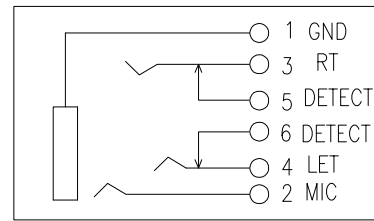
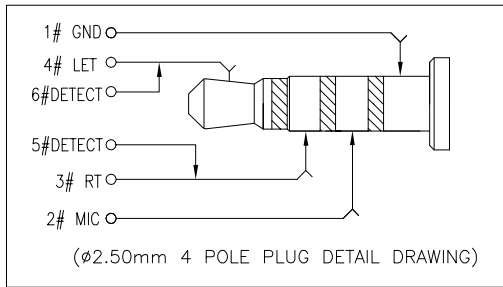

SCHEMATIC



ITEM	NAME	Q'TY	DESCRIPTION	NOTE
7	HOUSING	1	HIGHT TEMPERATURE PLASTIC; COLOR BLAC	
6	TERMINAL 6#	1	PHOSPHOR BRONZE; NICKEL UNDER PLATING OVERALL, GOLD FLASH PLATING ON SOLDER AREA; GOLD FLASH PLATING ON CONTACT AREA	
5	TERMINAL 5#	1	PHOSPHOR BRONZE; NICKEL UNDER PLATING OVERALL, GOLD FLASH PLATING ON SOLDER AREA; GOLD FLASH PLATING ON CONTACT AREA	
4	TERMINAL 4#	1	STAINLESS STEEL; NICKEL UNDER PLATING OVERALL, GOLD FLASH PLATING ON SOLDER AREA; GOLD FLASH PLATING ON CONTACT AREA	
3	TERMINAL 3#	1	STAINLESS STEEL; NICKEL UNDER PLATING OVERALL, GOLD FLASH PLATING ON SOLDER AREA; GOLD FLASH PLATING ON CONTACT AREA	
2	TERMINAL 2#	1	PHOSPHOR BRONZE; NICKEL UNDER PLATING OVERALL, GOLD FLASH PLATING ON SOLDER AREA; GOLD FLASH PLATING ON CONTACT AREA	
1	TERMINAL 1#	1	PHOSPHOR BRONZE; THE BOTTOM OF THE NICKEL; THE WHOLE GOLD PLATING	

THIS DOCUMENT IS THE SOLE PROPERTY OF **BBJconn Technology Co., Ltd.** Corporation AND SHOULD NOT BE USED IN WHOLE OR IN PART WITHOUT PRIOR WRITTEN PERMISSION.

深圳市步步精科技有限公司
PDWG.NO: 0076-1

APPD.	JM_Zheng	23/05/02	NAME:	2.5耳机座 有头 六脚贴 带柱 四节 (PJ25A001-F06G1BR-A)
CHKD.	LYX	23/05/02	PJ. NO.:	PJ.01.12-01-3003
DR.	SGF	23/05/02	SIZE:	A4 DRW NO.:
			FINISH:	SEE NOTES
			MAT'L.:	SEE NOTES
			SCALE:	N/A
			REV.:	A0
			UNIT:	mm
			PAGE:	1/1

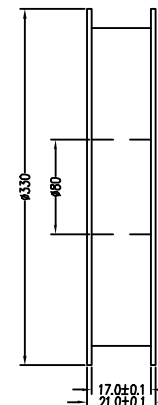
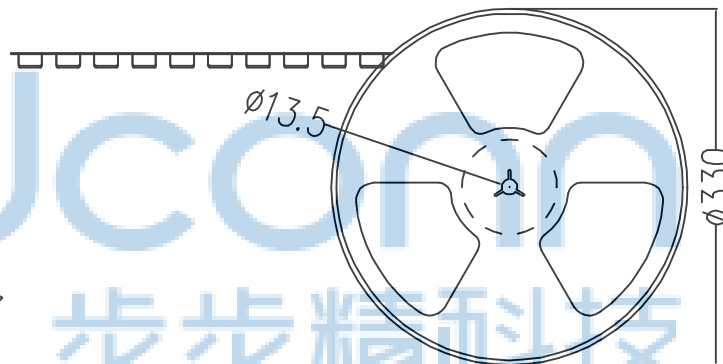
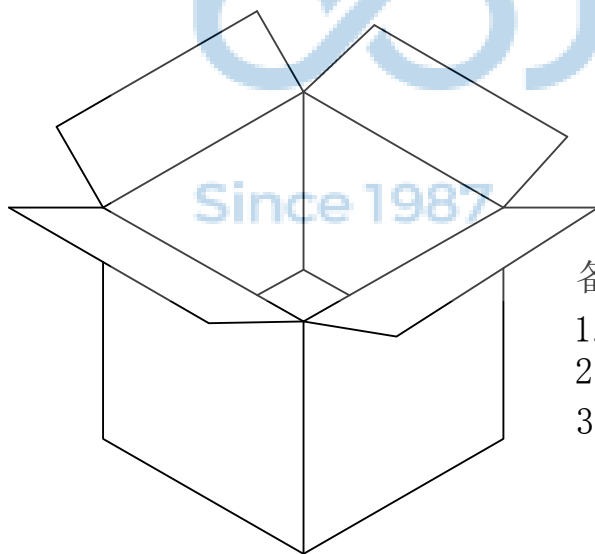
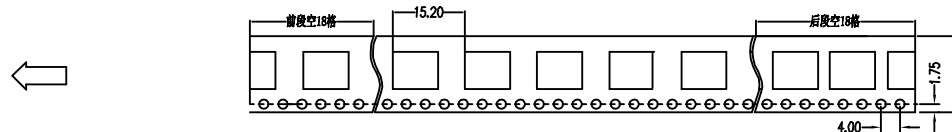
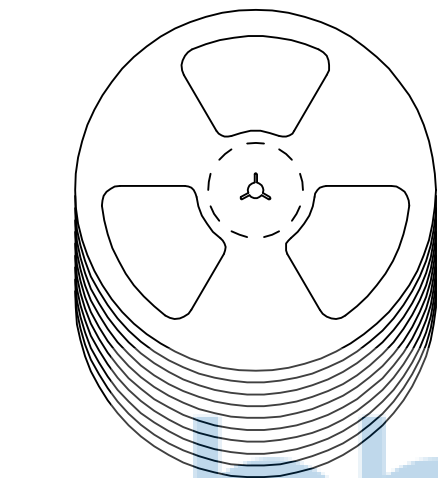

备注:

1. 包装数量: 1000/PCS/卷, 10卷/箱或15卷/箱。
2. 包装袋长度: 每卷前后各空10-20个空格, 中间包装。
3. 材质:
载体: 聚丙烯 (PS), 阻抗 $10^{6-9} \Omega$
上带: 聚乙烯 (PET), 阻抗 $10^{6-11} \Omega$
卷盘: 聚苯乙烯。

纸箱规格: 345*345*23MM

纸箱规格: 345*345*35MM

THIS DOCUMENT IS THE SOLE PROPERTY OF BBJconn Technology Co.,Ltd. Corporation AND SHOULD NOT BE USED IN WHOLE OR IN PART WITHOUT PRIOR WRITTEN PERMISSION.		深圳市步步精科技有限公司 .X: ±0.38 .X': ±3" .XX: ±0.25 .X': ±2" .XXX: ±0.13 .XX': ±1"		NAME: 2.5耳机座 有头 六脚贴 带柱 四节 (PJ25A001-F06G1BR-A)	
APPD.	JM_Zheng	23/05'02	PJ. NO.: PJ.01.12-01-3003		SIZE: A4
CHKD.	LYX	23/05'02	FINISH: SEE NOTES		MAT'L.: SEE NOTES
PDWG.NO:	0076-1	DR.	SGF	23/05'02	SCALE: N/A
				REV.: A0	UNIT: mm
				PAGE: 1/1	