

REV.	ECN NO.	CONTENT	DATE	ENGINEER
AO			2023 20/04	

SPECIFICATION:

1. RATING: DC 20V 5A
2. CONTACT RESISTANCE: 30m Ω MAX.
3. INSULATION RESISTANCE: 100 M Ω MIN.
4. WITHSTAND VOLTAGE: 500 VAC
5. INSERTION FORCE: 30N MAX.
6. EXTRACTION FORCE: 3N MIN.
7. DURABILITY: 5,000 CYCLES

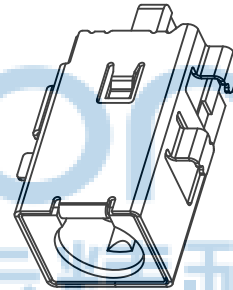
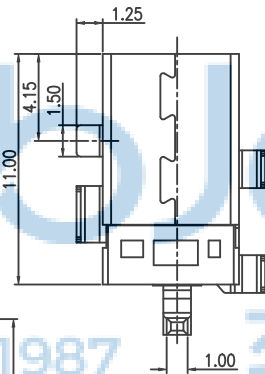
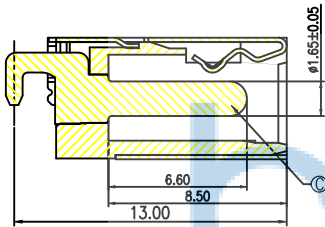
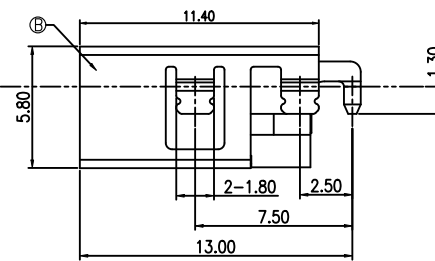
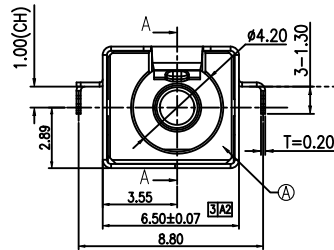
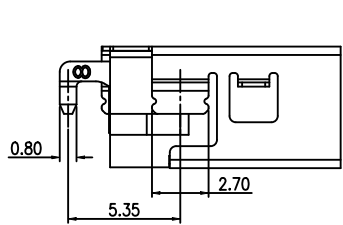

SECTION A-A
8.80

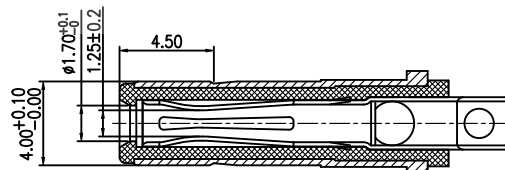
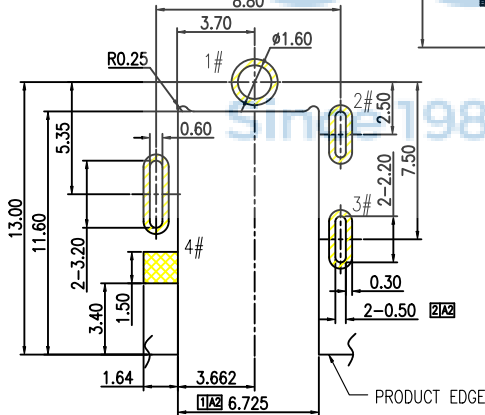

MATING PLUG

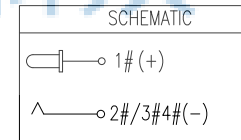

C	CENTER PIN	Zn ALLOY	GOLD FLASH/Ni 50u"	1
B	SHELL	COPPER ALLOY	Ni 50u"	1
A	HOUSING	HIGH TEMP.THERMOPLASTIC	BLACK	1
NO.	DESCRIPTION	MATERIAL	REMARKS	QTY

RECOMMENDED PCB LAYOUT
TOP VIEW TOLERANCE: ±0.05
■ PROHIBITED AREA



THIS DOCUMENT IS THE SOLE PROPERTY OF BBJconn Technology Co., Ltd. CORPORATION AND SHOULD NOT BE USED IN WHOLE OR IN PART WITHOUT PRIOR WRITTEN PERMISSION.		深圳市步步精科技有限公司 NAME: DC座 DC-1.65针 全铜 沉板式 三脚插(DC400170-0594-3000UH-A2 模型) APPD. JM_Zheng 23/05'02 CHKD. LYX 23/05'02 PDWG.NO: 0386-2 DR. SGF 23/05'02	
P.J. NO.: DC.03.52-12-G001		SIZE: A4 DRW NO.:	
FINISH: SEE NOTES		MAT'L: SEE NOTES	
SCALE: N/A		REV.: A3 UNIT: mm PAGE: 1/1	

REV.	ECN NO	CONTENT	DATE	ENGINEER
AO			2023 20/04	

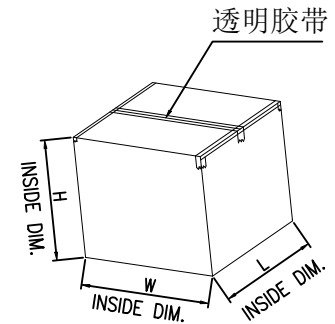
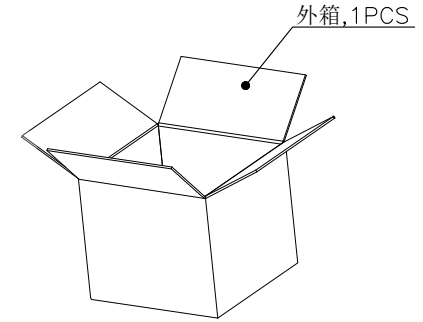
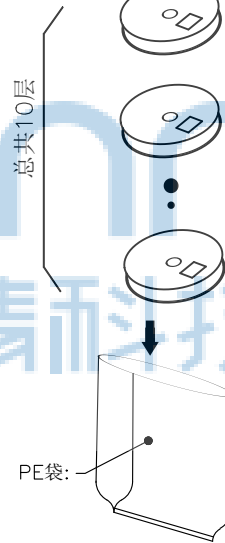
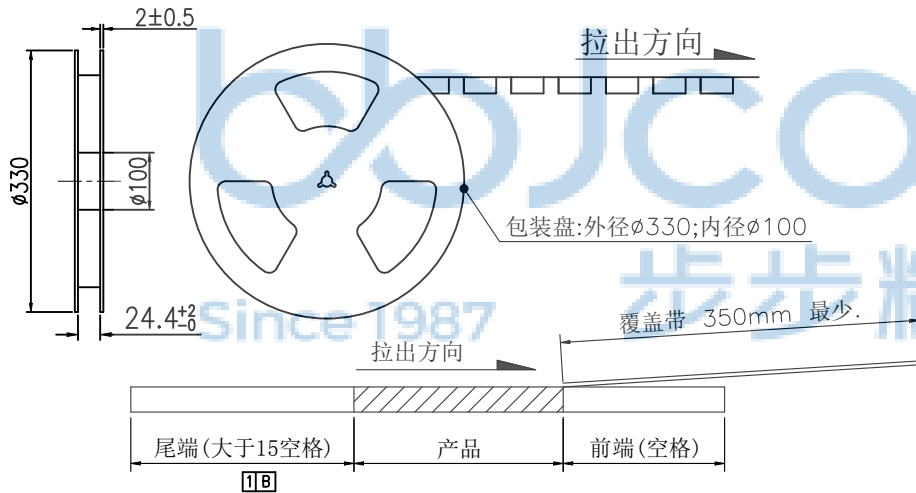
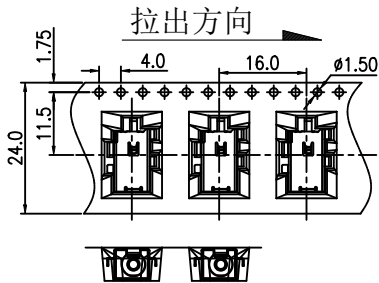

备注:

- 材料规格:
 - 载带: T=0.50mm, 黑色
 - 包装盘: 蓝色
 - 纸箱: L=335, W=335, H=300
- 包装数量: 600PCS/卷, 10卷(6000PCS)/箱
- 上盖带拔离力: 0.1N~0.7N(10~70gf);
拔离角度: 165°~180°;
拔离速度: 300mm/分钟.



THIS DOCUMENT IS THE SOLE PROPERTY OF BBJconn Technology Co., Ltd. CORPORATION AND SHOULD NOT BE USED IN WHOLE OR IN PART WITHOUT PRIOR WRITTEN PERMISSION.		深圳市步步精科技有限公司 .X: ±0.38 .X': ±3' .XX: ±0.25 .X'': ±2' .XXX: ±0.13 .X''': ±1'		NAME: DC座 DC-1.65针 全铜 沉板式 三脚插(DC400170-0594-3000UH-A2 模型) PJ. NO.: DC.03.52-12-G001 SIZE: A4 DRW NO.: FINISH: SEE NOTES MAT'L.: SEE NOTES SCALE: N/A REV.: A3 UNIT: mm PAGE: 1/1	
APPD.	JM_Zheng	23/05'02	CHKD.	LYX	23/05'02
PDWG.NO:	0386-2	DR.	SGF	23/05'02	