

REV.	ECN NO	CONTENT	DATE	ENGINEER
A0			2023 20/04	

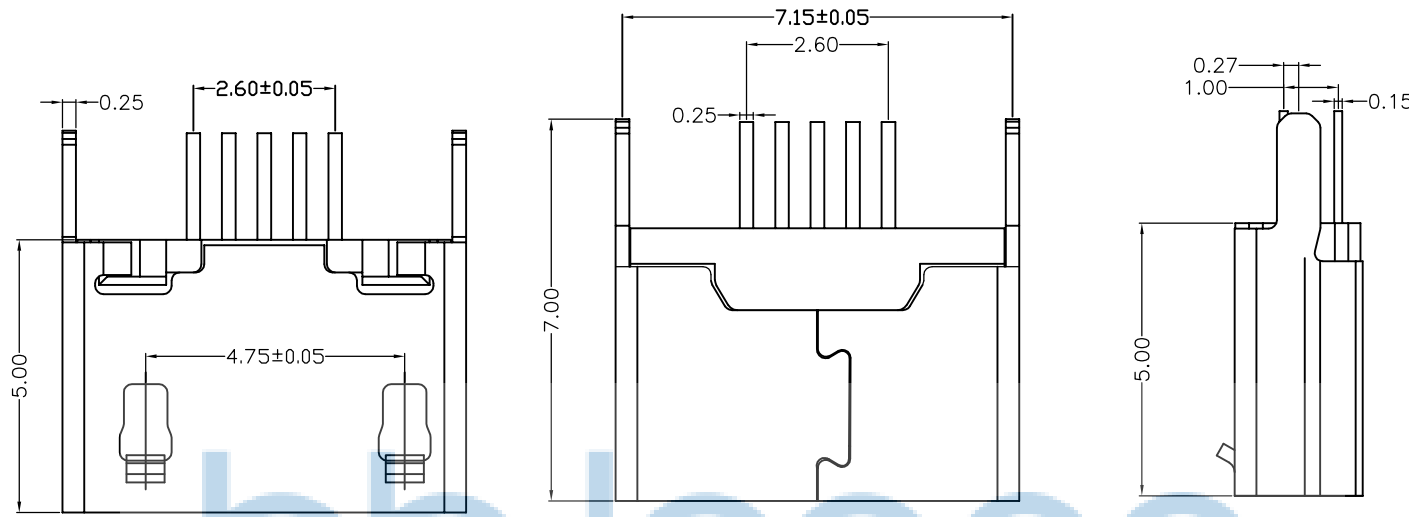

备注:

1. 产品规格:

- 1-1. 插入力: 35N MAX.
- 1-2. 拔出力: 10N MIN. INITIAL 8-20N AFTER 3000 CYCLES
- 1-3. 额定电流: 1.0A
- 1-4. 额定电压: 30V
- 1-5. 耐久性: 3000 CYCLES MIN.
- 1-6. 耐电压: 100V AC MIN.
- 1-7. 接触阻抗: 30mΩ MAX. INITIAL; 40mΩ MAX AFTER 3000 CYCLES
- 1-8. 绝缘电阻: 100MΩ MIN
- 1-9. 工作温度: -30° TO +80°

2. 材质:

- 2.1 胶芯: LCP UL94V-0
- 2.2 端子: C2680, 镍底, 镀金1μ"
- 2.3 外壳: SUS

3. 所用材质须符合RoHS要求

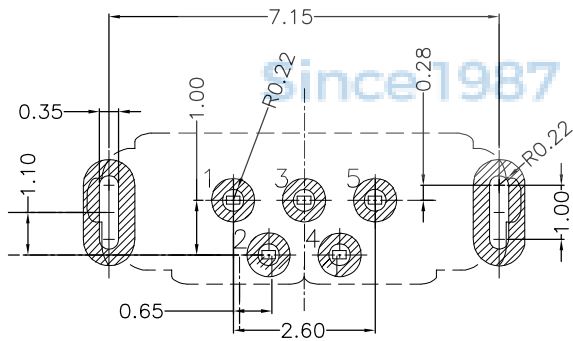

RECOMMENDED P.C.B LAYOUT

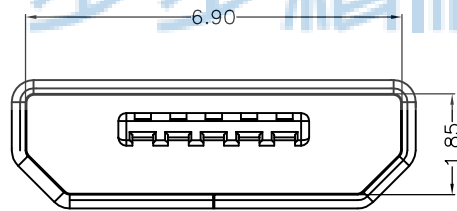

THIS DOCUMENT IS THE SOLE PROPERTY OF BBJconn Technology Co., Ltd. Corporation AND SHOULD NOT BE USED IN WHOLE OR IN PART WITHOUT PRIOR WRITTEN PERMISSION.		深圳市步步精科技有限公司 .X: ±0.38 .X': ±3" .XX: ±0.25 .X'': ±2" .XXX: ±0.13 .XX': ±1"		NAME: MICRO-5P BF 180度 直插 平口 H=5.0 不锈钢外壳 脚长2.0 雾锡 (加盖编带)	
APPD.	JM_Zheng	23/05/02	PJ. NO.: MC.01.82-11-1004 SIZE: A4 DRW NO.:		
CHKD.	LYX	23/05/02	FINISH: SEE NOTES MAT'L.: SEE NOTES		
PDWG.NO:	0113-1	DR.	SGF	23/05/02	SCALE: N/A REV.: A3 UNIT: mm PAGE: 1/1

REV.	ECN NO	CONTENT	DATE	ENGINEER
A0			2023 20/04	

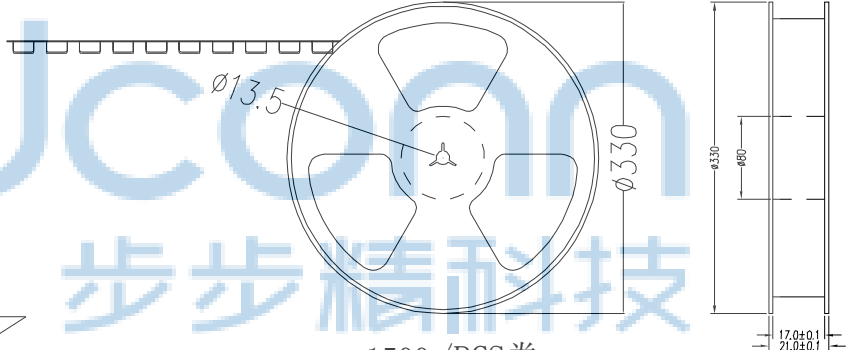
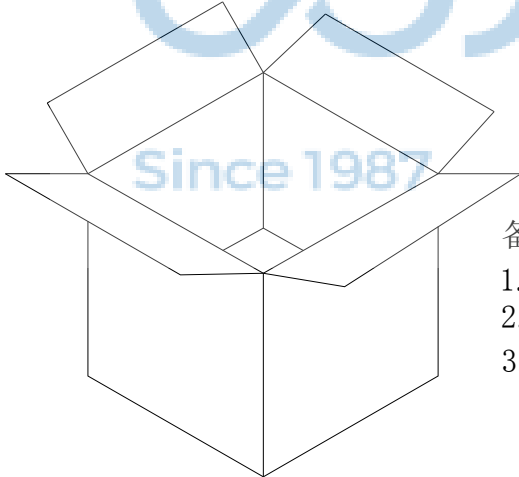
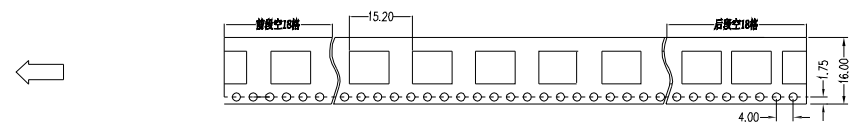
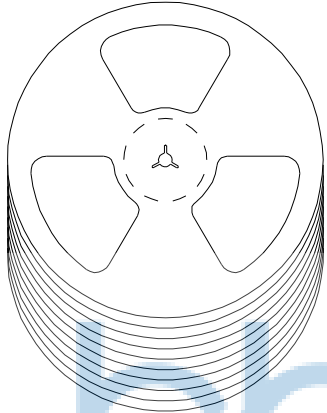

1500 /PCS卷

备注:

1. 包装数量: 1500 /PCS/卷, 10卷/箱或15卷/箱。
2. 包装袋长度: 每卷前后各空10-20个空格, 中间包装。
3. 材质:
载体: 聚丙烯 (PS), 阻抗 $10^{6-9} \Omega$
上带: 聚乙烯 (PET), 阻抗 $10^{6-11} \Omega$
卷盘: 聚苯乙烯。

纸箱规格: 345*345*23MM

纸箱规格: 345*345*35MM



THIS DOCUMENT IS THE SOLE PROPERTY OF BBJconn Technology Co.,Ltd. Corporation AND SHOULD NOT BE USED IN WHOLE OR IN PART WITHOUT PRIOR WRITTEN PERMISSION.		深圳市步步精科技有限公司 .X: ±0.38 .XX: ±0.25 .XXX: ±0.13 X': ±3" X'': ±2" XX': ±1"		NAME: MICRO-5P BF 180度 直插 平口 H=5.0 不锈钢外壳 脚长2.0 雾锡 (加盖编带) PJ. NO.: MC.01.82-11-1004 SIZE: A4 DRW NO.: FINISH: SEE NOTES MAT'L.: SEE NOTES SCALE: N/A REV.: A3 UNIT: mm PAGE: 1/1	
APPD.	JM_Zheng	23/05'02			
CHKD.	LYX	23/05'02			
PDWG.NO:	0113-1	DR.	SGF	23/05'02	