

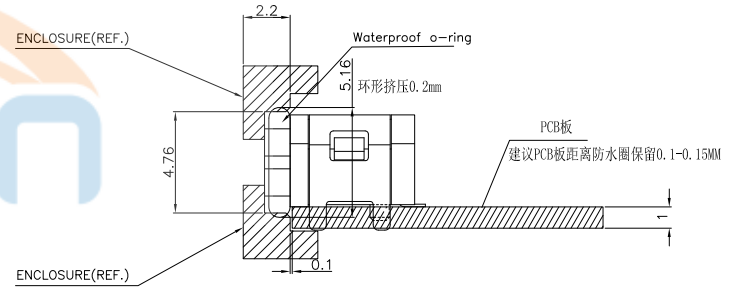

REV.	DESCRIPTION	NAME	DATE
A	NEWS ISSUE		

- NOTES:
SPECIFICATION:
- CURRENT RATING: 5.0A MAX
 - VOLTAGE: 100 VAC
 - TEMPERATURE RANGE: -30 °C ~ 85 °C
 - CONTACT RESISTANCE: 40 MILLIONHM MAX
 - INSULATION RESISTANCE: 100 MEGOHMS MIN.
 - INSERTION FORCE : 5N~20N
 - UNMATING FORCE: 8N~20N
 - DURABILITY: 10,000 CYCLES
 - WATER PROOFNESS: THIS PRODUCT IS BASED ON IP65.

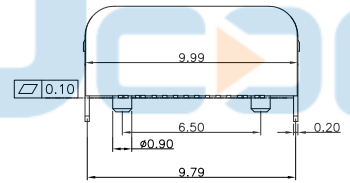
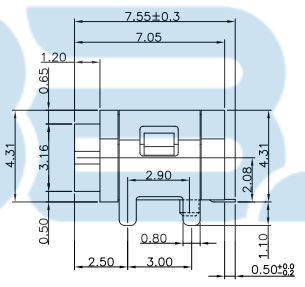
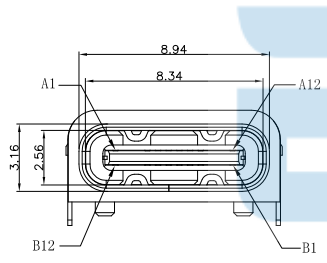
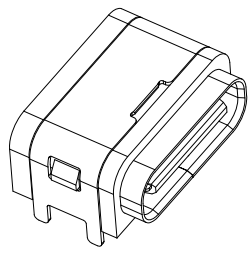
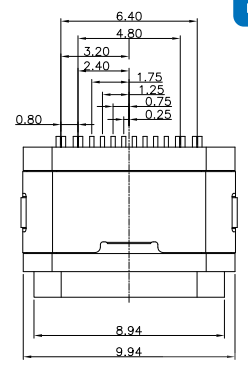
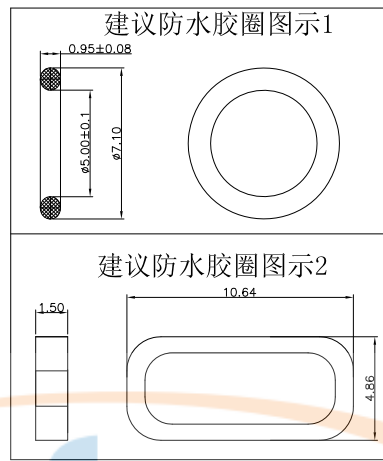

RECOMMENDED SCHEMATIC DRAWING OF CONNECTOR MATCH CHASSIS

电流5A, 端子C1814, 主体塑胶PA9T, 外塑胶 LCP130I, 金手指镀金3U'', 锡脚1U'', 外壳 304, 卡锁301, 寿命10000次.

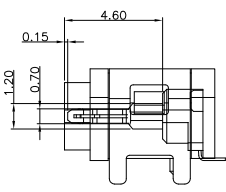
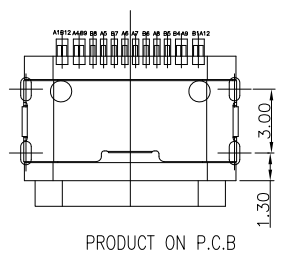
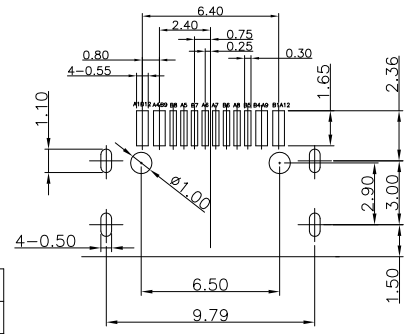

A1	GND	B12	GND
A4	VBUS	B9	VBUS
A5	CC1	B8	SBU2
A6	DP1	B7	DN2
A7	DN1	B6	DP2
A8	SBU1	B5	CC2
A9	VBUS	B4	VBUS
A12	GND	B1	GND
PIN	SIGNAL NAME	PIN	SIGNAL NAME



TOLERANCE UNSPECIFIED		深圳市步步精科技有限公司 TITLE: TYPE-C 16P 防水母座 板上四脚插 带柱 L=7.05 CH=2.08 IPX5 O型防水圈	
.0 ±0.35 .00 ±0.25 .000 ±0.15 X. ° ±2.00° CUSTOMER DRAWING	DRAWN/ DATE 设计 LYX CHECKED/ DATE 审核 HMY APPROVED/ DATE 核准 LJP	SIZE: A4 UNIT: MM SCALE: 1:1 DWG. PATH	PART. NO.: UC.01.51-1W-0013 PROJECTION REV.: A0 SHEET: 页码



REV.	DESCRIPTION	NAME	DATE
A	NEWS ISSUE		

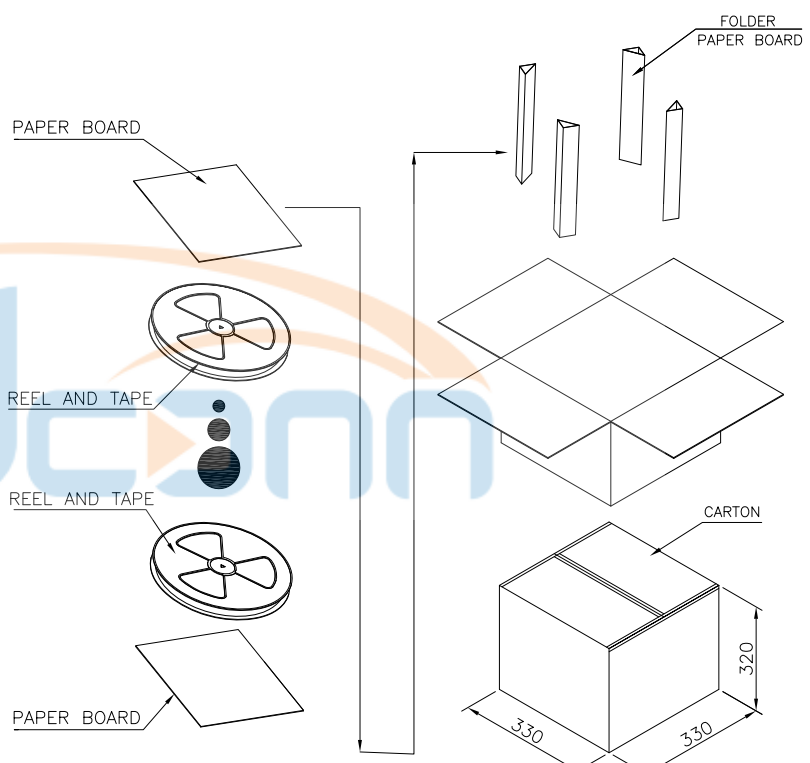
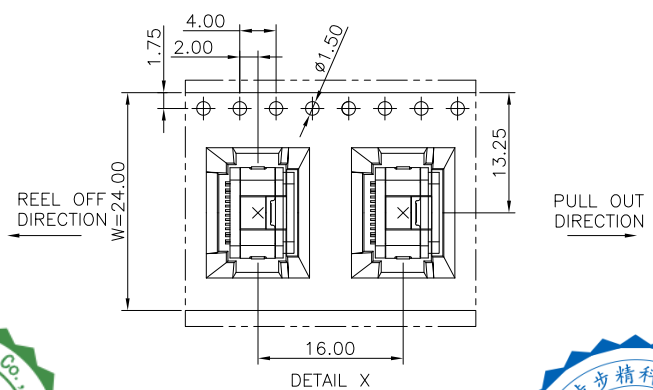
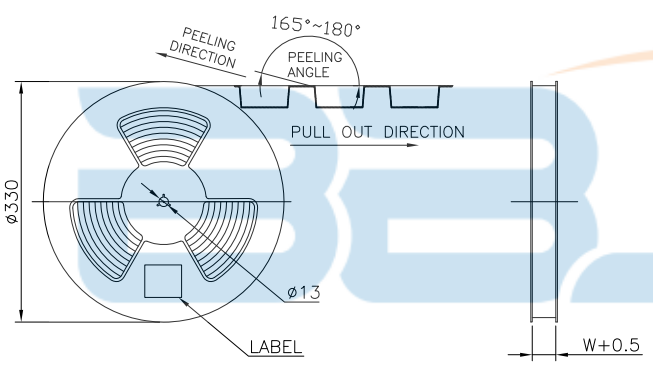
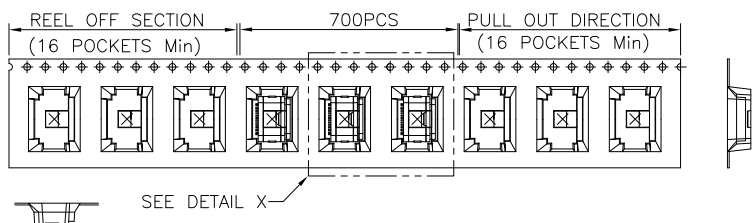

	REEL	CARTON
CONNECTOR (PCS)	700	7000



TOLERANCE UNSPECIFIED		.0 ±0.35		.00 ±0.25		.000 ±0.15		X. ° ±2.00°		CUSTOMER DRAWING	
BBJconn 深圳市步步精科技有限公司 TITLE: TYPE-C 16P 防水母座 板上四脚插 带柱 L=7.05 CH=2.08 IPX5 0型防水圈											
DRAWN/ DATE	设计	LYX	SIZE:A4	UNIT:MM.	PART. NO:	UC.01.51-1W-0013					
CHECKED/ DATE	审核	HMY	SCALE: 1:1		PROJECTION			REV. : A0			
APPROVED/ DATE	核准	LJP	DWG.	PATH	0541-1			SHEET: 页码			