

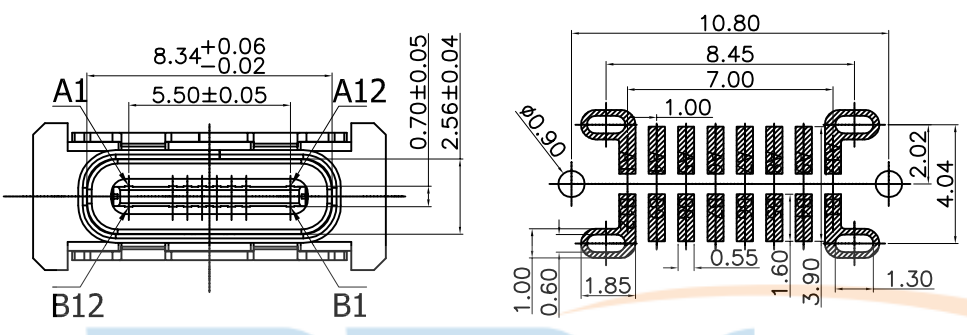

REV.	DESCRIPTION	NAME	DATE
A	NEWS ISSUE		

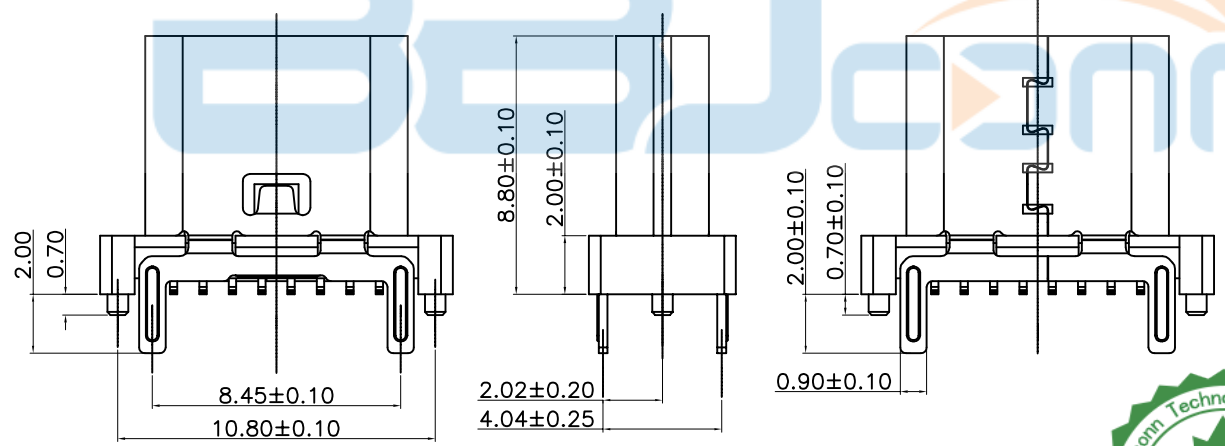

- 特性:
- 电气性能: ELECTRICAL
    - 额定电流: 5.0A
    - 接触阻抗: 40 MILLIOHMS MAX
    - 耐电压: 100V AC / 1 mA MAX
    - 绝缘阻抗: 150V DC/100 MEGA OHMS MIN
  - 机械性能:
    - 插入力: 5~20N 2. 拨出力: 8~20N
    - 使用寿命: 10000次、拨出力 5N MIN
  - 材料: MATERIAL
  - 电镀: FINISH
    - 端子: 接触点镀金1U"MIN  
PIN脚焊接区域镀锡80U"MIN
    - 外壳: 镀镍80U"MIN (盐雾48H)
  - 电镀品需做粘锡测试: 粘锡面积达到95%以上。
  - SMT回流焊 (峰值260° C±5° C) 不能起泡、熔胶、变色不良 (变形在公差范围以内)
  - 工作温度: -55° C~+85° C
  - 盐雾测试: 通过48H在浓度为5±1%盐水的盐雾测试无生锈现象



A1	A2	A3	A4	A5	A6	A7	A8	A9	A10	A11	A12
GND			VBUS	CC1	D+	D-	SBU1	VBUS			GND
GND			VBUS	SBU2	D-	D+	CC2	VBUS			GND
B12	B11	B10	B9	B8	B7	B6	B5	B4	B3	B2	B1

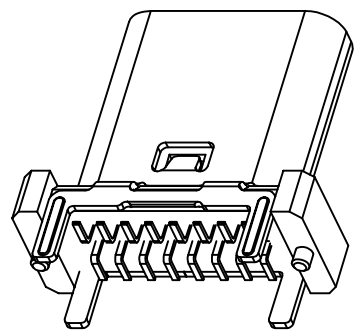
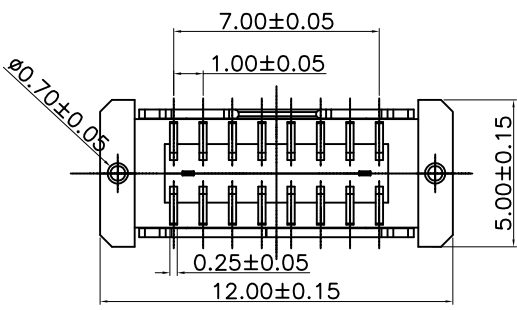

BOM				
序号	名称	料号	用量	品名规格
1	外壳		1	Typec立插 外壳 SUS304 T=0.30mm
2	Molding 3		1	Typec立插 SMT 16PIN Molding C7025 LCP黑色 半成品
2.1	Molding 1		1	Typec立插 SMT 16PIN Molding A C7025 LCP黑色
2.2	Molding 2		1	Typec立插 SMT 16PIN Molding B C7025 LCP黑色
2.3	卡勾		1	Typec立插 16PIN 卡勾 SUS301 T=0.15mm

GENERAL TOLERANCE		深圳市步步精科技有限公司 TITLE: Type-C 16PIN母座 直立式 SMT 四脚插带柱 H=8.8			
0. ±0.35 0.0 ±0.25 0.00 ±0.15 0.° ±4° 0.0° ±3°					
DRAWN/ DATE	设计 LYX	SIZE:A4	UNIT:MM.	PART. NO: UC.01.61-1K-0008	
CHECKED/ DATE	审核 GY	SCALE: 1:1		PROJECTION	REV.: 版本
APPROVED/ DATE	核准 LJP	DWG. PATH	0454-1		SHEET: 页码



REV.	DESCRIPTION	NAME	DATE
A	NEWS ISSUE		

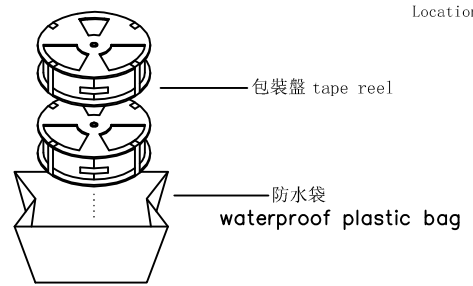
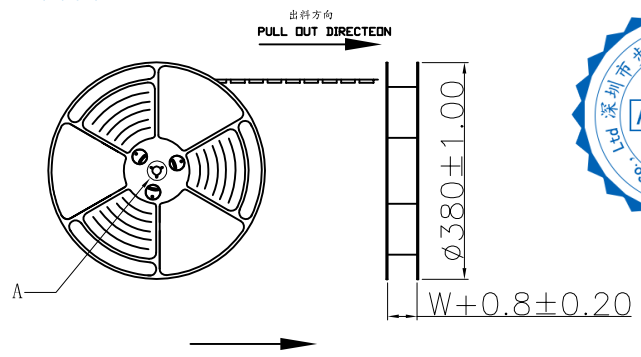

at small positioning hole of the carrier tape side.  
 標籤黏貼處 (朝捲裝包材的小定位孔一側)  
 Location of label sticking (label)

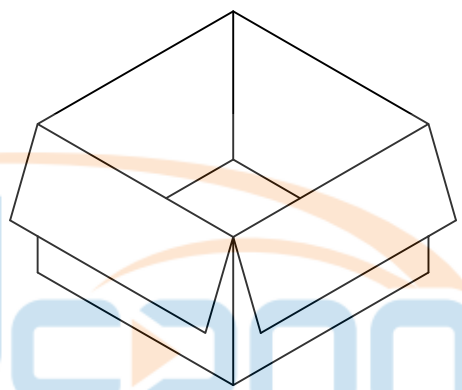
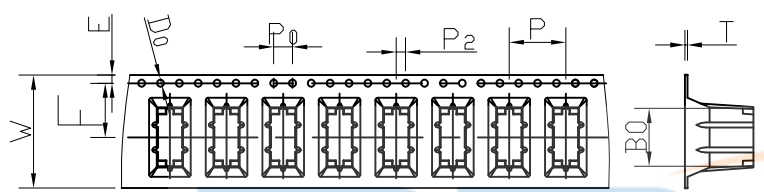
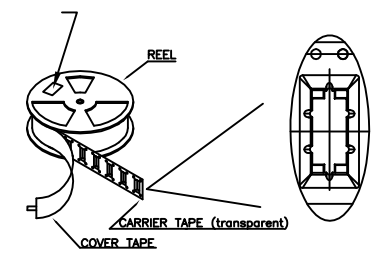

紙箱: 390mmX390mmX310mm

NOTE:

1. 每捲包裝數量及每箱裝箱數量如左下表格。  
Packing q'ty of each reel & carton as below table shown.
2. 將裝滿產品的卷盤放入紙箱并以膠帶封口  
Put reels in the carton and use adhesive tape to seal up.

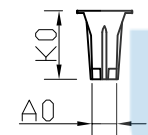

NOTES

1. 帶子引導長度  
LEAD TAPE LENGTH  
出料方向  
PULL OUT DIRECTION

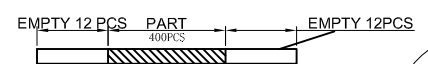

2. 上帶 剝力為:  $0.1 \sim 1.3N$  (10.2gf~130gf)  
 PEELING OFF FORCE OF TOP TAPE:  $0.1 \sim 1.3N$  (10.2gf~130gf)  
 出貨 運輸過程中一定注意:  
 THIS REQUIREMENT SHOULD BE APPLIED AT SHIPMENT:  
 卷帶在運輸過程中不能散開  
 PEELING OFF SHOULD NOT BE ALLOWED DURING TRANSPORTATION

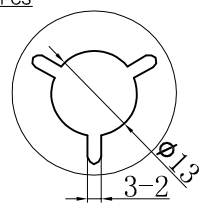

DETAIL: A  
10:1



W	24.00±0.3
A0	5.24±0.1
B0	12.30±0.1
K0	13.35±0.1
P	12.00±0.1
F	11.50±0.1
E	1.75±0.1
D0	1.50±0.1
P0	4.00±0.1
P2	2.00±0.1
T	0.50±0.05

卷帶	規格: $\phi 380mm$	包裝數量: 600PCS
紙箱	規格: 390mmX390mmX310mm	包裝數量: 10盤 (6000PCS)

GENERAL TOLERANCE		深圳市步步精科技有限公司 TITLE: Type-C 16PIN母座 直立式 SMT 四腳插帶柱 H=8.8			
DRAWN/ DATE	设计 LYX	SIZE: A4	UNIT: MM.	PART. NO: UC.01.61-1K-0008	
CHECKED/ DATE	审核 GY	SCALE: 1:1		PROJECTION	REV.: 版本
APPROVED/ DATE	核准 LJP	DWG. PATH	0454-1		SHEET: 页码