

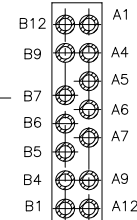

REV.	DESCRIPTION	NAME	DATE
A	NEWS ISSUE		

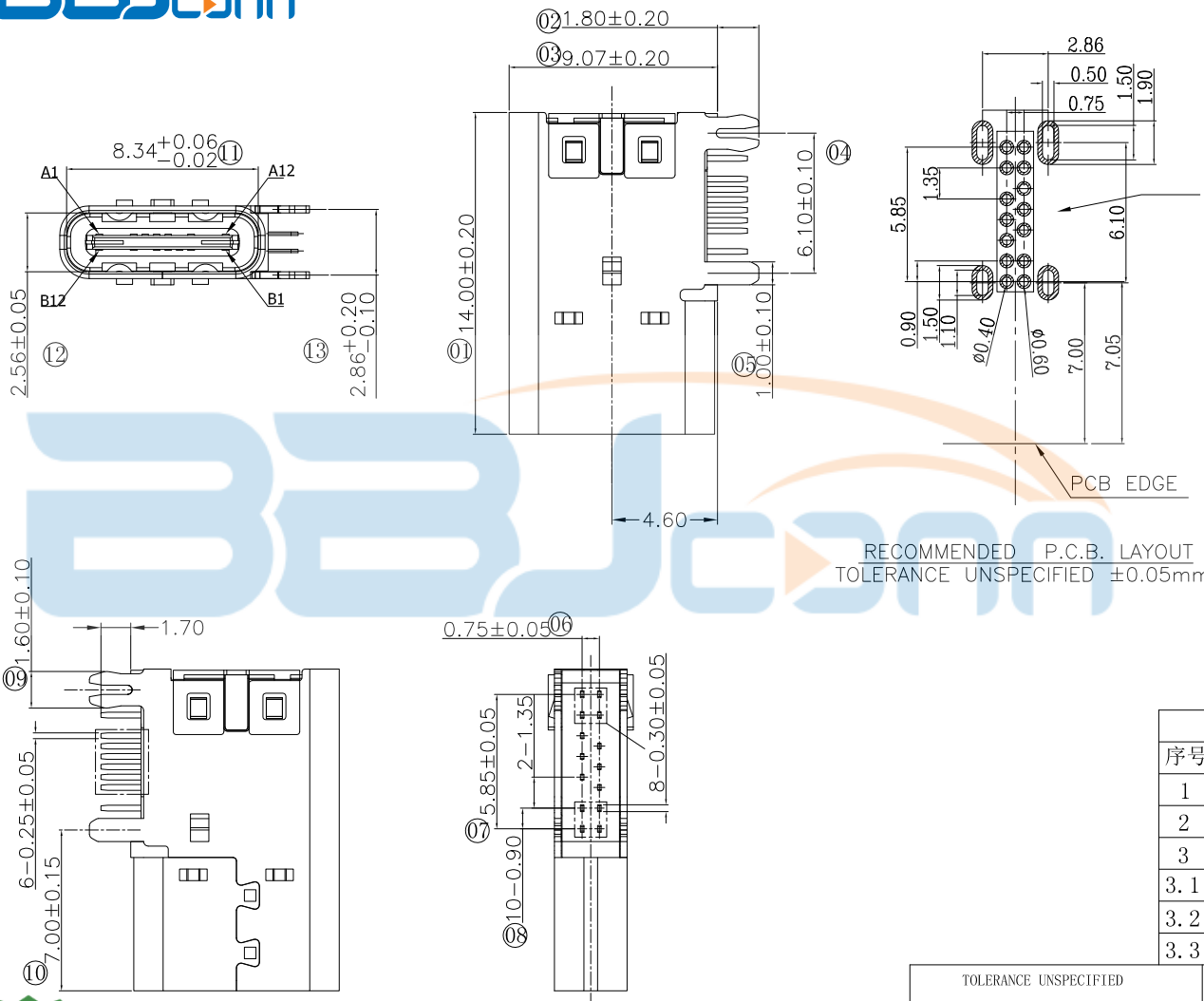

特性:

- 一、电气性能: ELECTRICAL
 1. 额定电流: 5.0A MAX
 2. 接触阻抗: 30 MILLIOHMS MAX
 3. 耐电压: 150V AC / 1 mA MAX
 4. 绝缘阻抗: 150V DC/100 MEGA OHMS MIN
- 二、机械性能:
 1. 插入力: 5-20N
 2. 拨出力: 8-20N
 3. 使用寿命: 10000次
- 三、材料: MATERIAL
- 四、电镀: FINISH
 1. 端子: 接触点镀金1U²
PIN脚焊接区域测金.
 2. 外壳: 镀哑镍40U²MIN (盐雾24H)
- 五、电镀品需做粘锡测试: 粘锡面积达到95%以上。
- 六、SMT回流焊 (峰值260° C±5° C) 不能起泡、熔胶、变色不良 (变形在公差范围以内)
- 七、工作温度: -55° C~+85° C
- 八、盐雾测试:
 - 通过24H在浓度为5±1%盐水的盐雾测试无生锈现象;
- 九、管制重点尺寸。

RECOMMENDED P.C.B. LAYOUT
TOLERANCE UNSPECIFIED ±0.05mm

BOM

序号	名称	用量	品名规格
1	外壳	1	Typec侧插14PIN 普通外壳 (4.58) SUS304 T=0.3mm
2	后盖	1	Typec侧插14PIN 后盖 SUS201 T=0.2mm
3	Molding 3	1	Typec侧插 Molding DIP 14PIN 黄铜 LCP黑色 4.58 半成品
3.1	Molding 1	1	Molding DIP 14PIN Molding 上 黄铜 LCP黑色 4.58
3.2	Molding 1	1	Molding DIP 14PIN Molding 下 黄铜 LCP黑色 4.58
3.3	卡勾	1	Typec侧插 DIP 14PIN 卡勾 SUS301 T=0.15

TOLERANCE UNSPECIFIED

0.	±0.25
0.0	±0.20
0.00	±0.15
0.°	±4°
0.0°	±3°



TITLE: TYPE-C 母座 90度侧插14PIN L=14.0 前小脚后鱼叉脚
不垫高带后盖 CH=4.6 脚长1.7 (TC0114223)

DRAWN/ DATE	设计 GY	SIZE:A4	UNIT:MM.	PART. NO:	UC. 01. 44-4K-0001
CHECKED/ DATE	审核 LYX	SCALE: 1:1	PROJECTION		REV.: 版本
APPROVED/ DATE	核准 LJP	DWG. PATH	0454-1	SHEET: 页码	

A1	A2	A3	A4	A5	A6	A7	A8	A9	A10	A11	A12
GND			VBUS	CC1	D+	D-		VBUS			GND
GND			VBUS		D-	D+	CC2	VBUS			GND
B12	B11	B10	B9	B8	B7	B6	B5	B4	B3	B2	B1



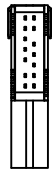

产品

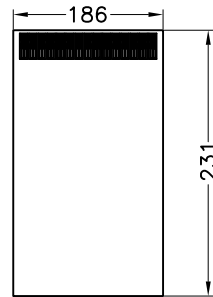
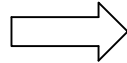

吸塑盘: 150PCS/盘

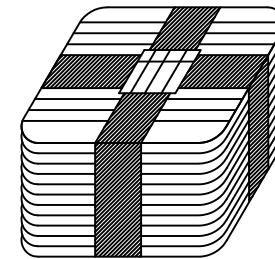
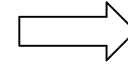

吸塑盘: 10盘/扎

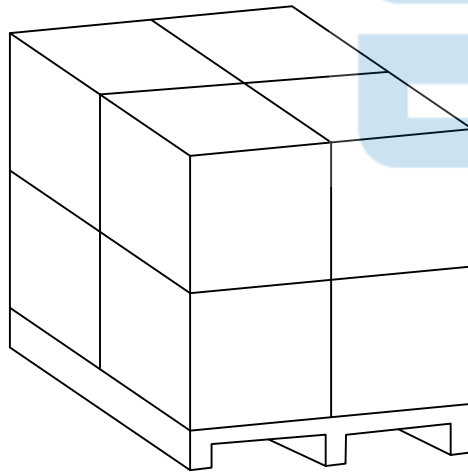

放置地

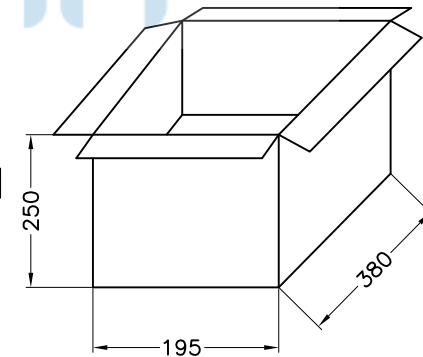
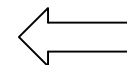
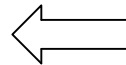
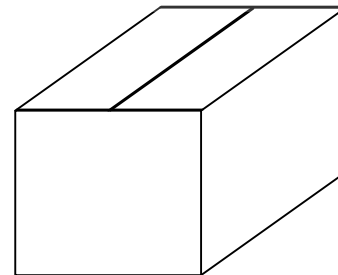

注释:

- 吸塑盒: 2.31*1.86*0.8/CM
- 数量: 150PCS/盒
6000PCS/箱
- 纸箱: 38*25*19.5CM

TOLERANCE UNSPECIFIED		深圳市步步精科技有限公司 TITLE: TYPE-C 母座 90度 侧插 14PIN L=14.0 前小脚后鱼叉脚 不垫高带后盖 CH=4.6 脚长1.7 (TC0114223)			
0. ±0.25	0.0 ±0.20	0.00 ±0.15	0.° ±4°	0.0° ±3°	
DRAWN/ DATE	设计 GY	SIZE: A4	UNIT: MM.	PART. NO: UC.01.44-4K-0001	
CHECKED/ DATE	审核 LYX	SCALE: 1:1	PROJECTION		REV.: 版本
APPROVED/ DATE	核准 LJP	DWG. PATH	0454-1		SHEET: 页码

REV.	DESCRIPTION	NAME	DATE
A	NEWS ISSUE		