

NOTES:

SPECIFICATION:

1. CURRENT RATING: 3.0A MAX
2. VOLTAGE: 100 VAC
3. TEMPERATURE RANGE: -30 °C ~ 85 °C
4. CONTACT RESISTANCE: 40 MILLIONHM MAX
5. INSULATION RESISTANCE: 100 MEGOHMS MIN.
6. INSERTION FORCE : 5N~20N
7. UNMATING FORCE: 8N~20N
8. DURABILITY: 10,000 CYCLES

REV.	DESCRIPTION	NAME	DATE
A			

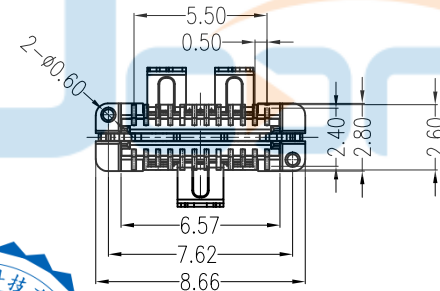
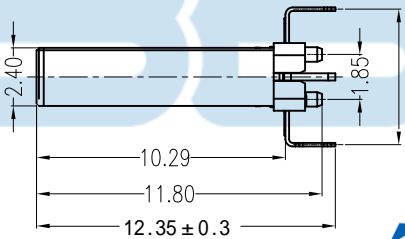
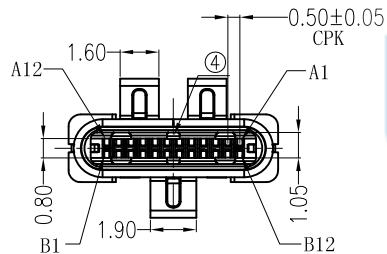

NO.	DESCRIPTION	MATERIAL	REMARKS	QTY
5	COVER	HIGH TEMPERATURE PLASTIC	LCP BLACK	1PCS
4	SPRING	STAINLESS STEEL	---	2PCS
3	LATCH	STAINLESS STEEL	TIN: 80-120u"Min/Ni base: 50u"Min Plated	1PCS
2	SHELL	STAINLESS STEEL	Ni: 50u"Min Plated	1PCS
1	TERMINAL HOUSING	HIGH TEMPERATURE PLASTIC	LCP BLACK/CONTACT: Au: 1u"Min Ni base: 50u"Min	2PCS

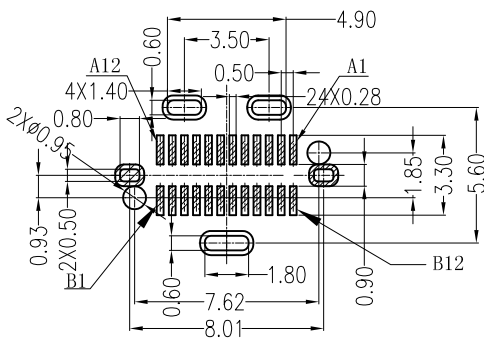

PIN	SIGNAL NAME	PIN	SIGNAL NAME
A1	GND	B12	GND
A2	SSTXP1	B11	SSRXP1
A3	SSTXN1	B10	SSRXN1
A4	VBUS	B9	VBUS
A5	CC1	B8	SBU2
A6	DP1	B7	DN2
A7	DN1	B6	DP2
A8	SBU1	B5	CC2
A9	VBUS	B4	VBUS
A10	SSRXN2	B3	SSTXN2
A11	SSRXP2	B2	SSTXP2
A12	GND	B1	GND

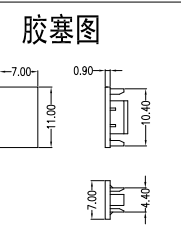

深圳市步步精科技有限公司

TITLE: TYPE-C 24P 直立式公头 H=11.1 双排SMT 三脚插 带定位

DRAWN/ DATE: 设计 GY

CHECKED/ DATE: 审核 LYX

APPROVED/ DATE: 核准 LJP

SIZE: A4 UNIT: MM. PART. NO.: UC.02.62-15-0001

SCALE: 1:1 PROJECTION: REV.: 版本

DWG. PATH: 0046-1 SHEET: 页码

RECOMMENDED PCB LAYOUT(L=0.80±0.05)
COMPONENT SIDE(GENERAL TOLERANCE:±0.05)



REV.	DESCRIPTION	NAME	DATE
A			

出料方向
PULL OUT DIRECTEON

NOTES

1. 帶子引導長度
LEAD TAPE LENGTH
出料方向
PULL OUT DIRECTEON

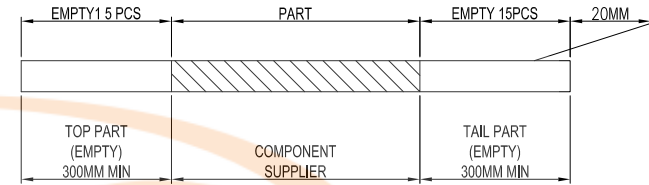

2. 上帶 剝力力為 : 0.1~1.3N(10.2gf~130gf)
PEELING OFF FORCE OF TOP TAPE: 0.1~1.3N(10.2gf~130gf)
出貨運輸過程中一定注意 :
THIS REQUIREMENT SHOULD BE APPLIED AT SHIPMENT :
卷帶在運輸過程中不能散開
PEELING OFF SHOULD NOT BE ALLOWED DURING TRANSPORTATION

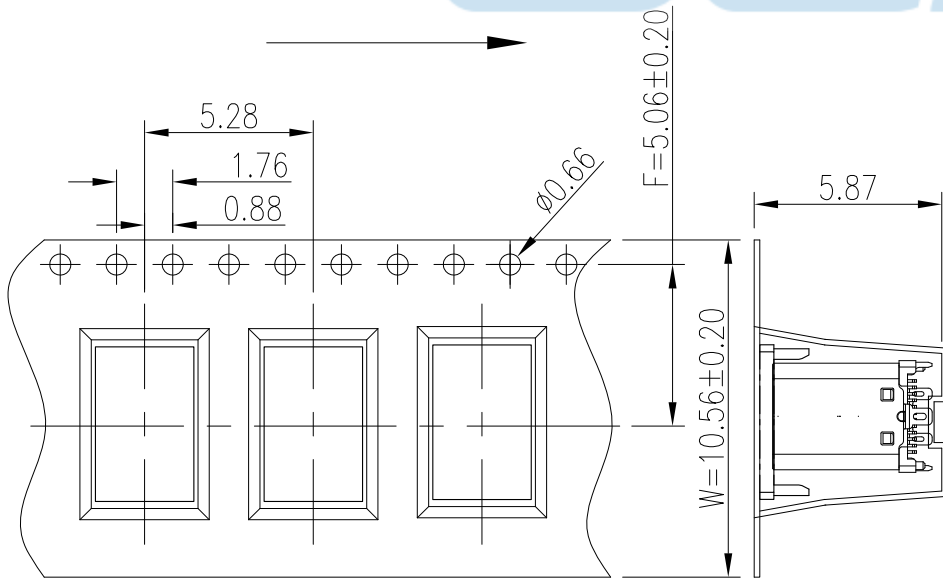
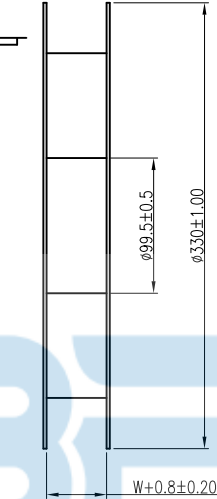
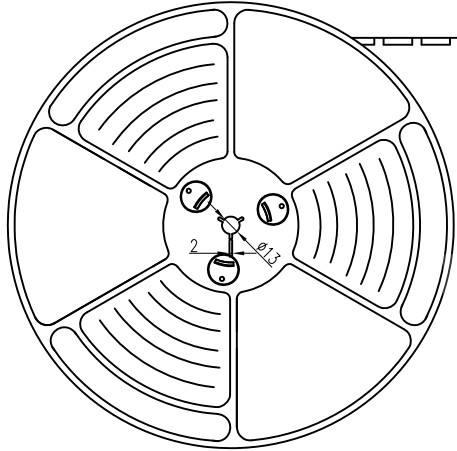
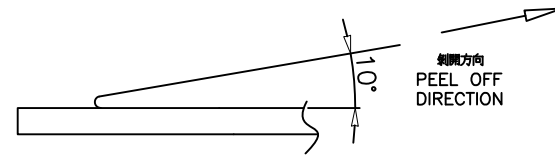

GENERAL TOLERANCE:		深圳市步步精科技有限公司 TITLE: TYPE-C 24P 直立式公头 H=11.1 双排SMT 三脚插 带定位			
DRAWN/ DATE	设计 GY	SIZE: A4	UNIT: MM.	PART. NO:	UC.02.62-15-0001
CHECKED/ DATE	审核 LYX	SCALE: 1:1	PROJECTION	REV.:	版本
APPROVED/ DATE	核准 LJP	DWG. PATH	0046-1	SHEET:	页码



REV.	DESCRIPTION	NAME	DATE
A			

at small positioning hole of the carrier tape side).

標籤黏貼處 (朝捲裝包材的小定位孔一側)

Location of label sticking (label

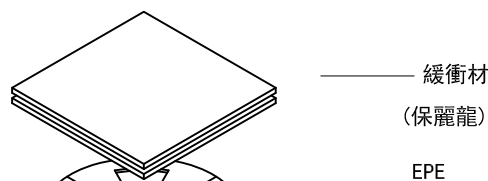

緩衝材
(保麗龍)
EPE

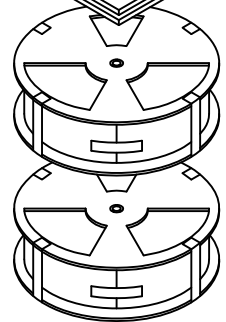

包裝盤 tape reel

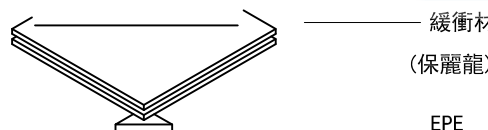

緩衝材
(保麗龍)
EPE

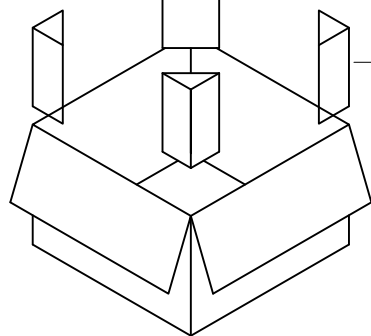

防撞三角柱 (4Pcs)

紙箱 carton

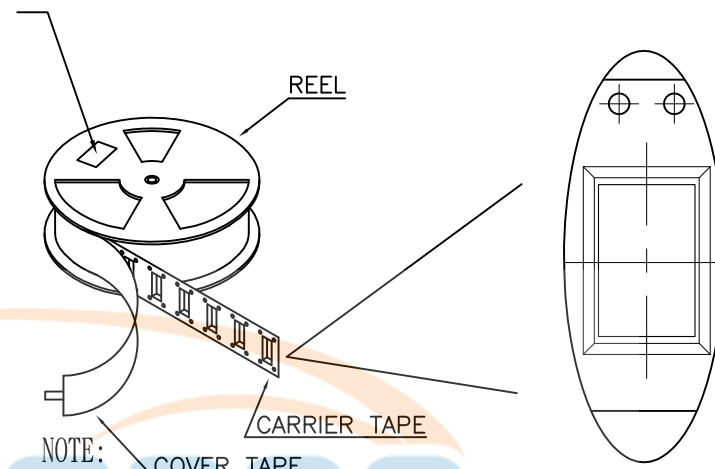

NOTE: COVER TAPE

1. 每捲包裝數量及每箱裝箱數量如左下表格。
Packing q'ty of each reel & carton as below table shown.
2. 以上膠帶覆蓋下包裝帶經包裝機熱熔包裝
Use cover tape to cover and hot melt machine to seal up.
3. 每個紙箱放2個珍珠棉
Every carton use 2pcs EPE.
4. 將裝滿產品的卷盤放入紙箱並以膠帶封口
Put reels in the carton and use adhesive tape to seal up.



包裝容量 (PACKING CAPACITY)			重量 WEIGHT (Kg)			外箱尺寸 (Outer box size)
PCS/REEL	REELS/CARTON	PCS/CARTON	N.W./PCS	N.W./BOX	G.W./BOX	mm
300	11	3300				340*340*330mm

GENERAL TOLERANCE: 0. ±0.38 0.0 ±0.25 0.00 ±0.15 0.0° ±2°		深圳市步步精科技有限公司 TITLE: TYPE-C 24P 直立式公头 H=11.1 双排SMT 三脚插 带定位					
DRAWN/DATE	设计 GY	SIZE:A4	UNIT:MM.	PART. NO:	UC.02.62-15-0001		
CHECKED/DATE	审核 LYX	SCALE: 1:1	PROJECTION			REV.: 版本	
APPROVED/DATE	核准 LJP	DWG. PATH	0046-1		SHEET: 页码		